

1991

ИЗЪ КНИГЪ
ИНЖЕНЕРА
Л. І. ЯНЫШЕВА.

Библиотека Института
Геодезии и Картографии
Дата 2007

526
579

Ч Е Р Т Е Ж И

къ

К У Р С У

ВЫСШЕЙ И НИЗШЕЙ ГЕОДЕЗИИ,

05590

А. Болотова.

Тетрадь

С. ПЕТЕРБУРГЪ,
1845.

1975

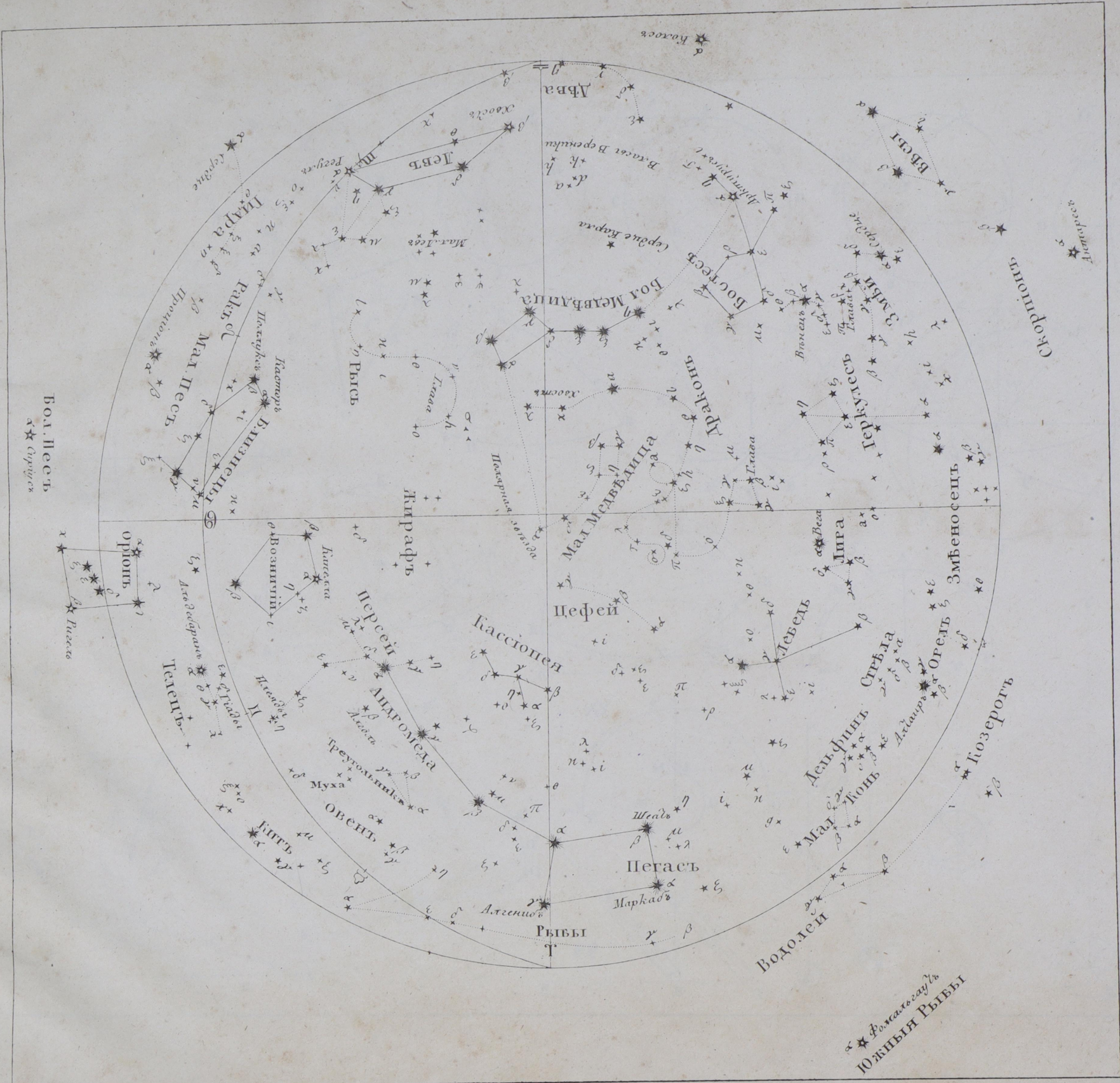

α * Волосы Змьи
Южнiя Рыбь

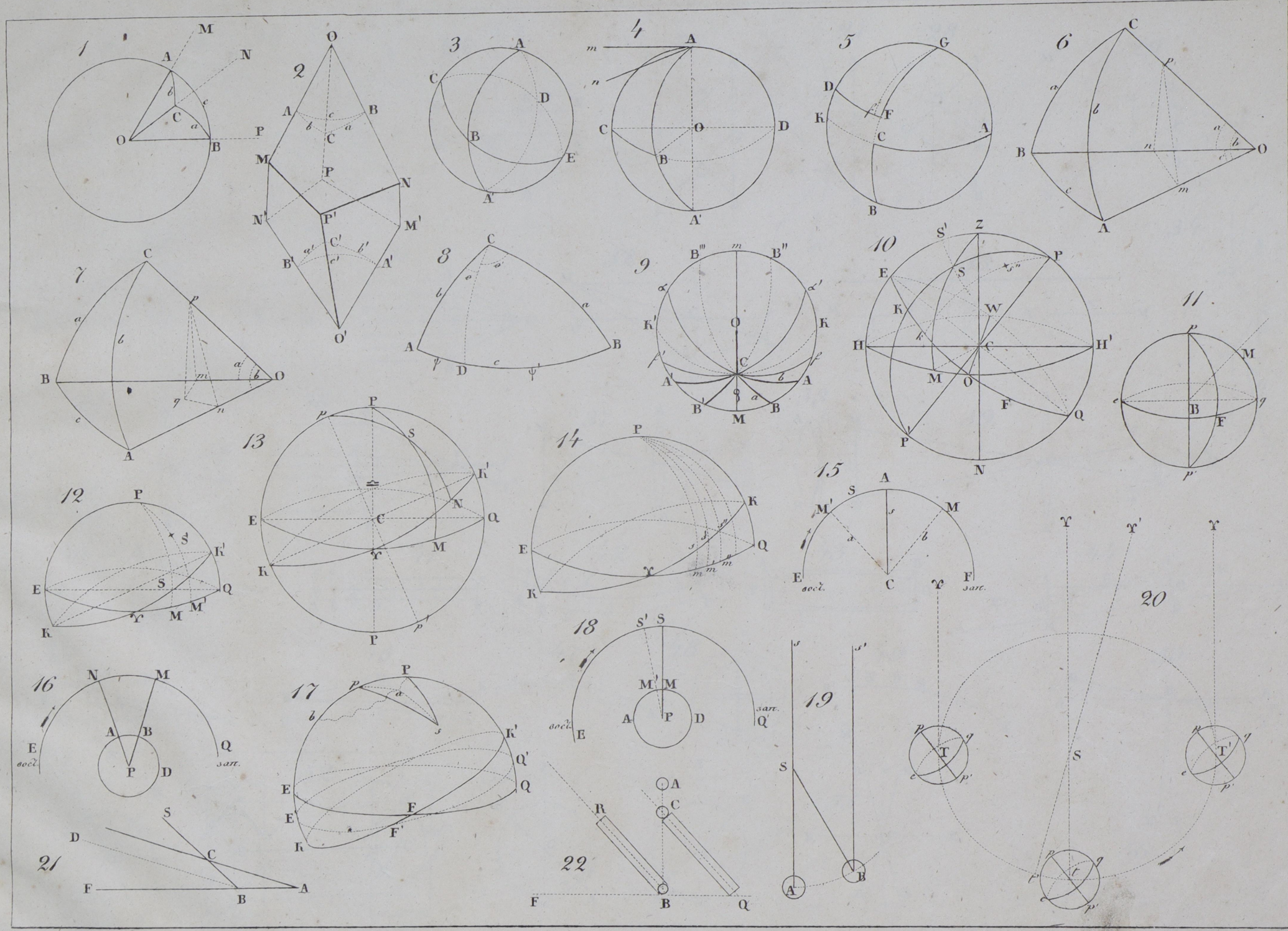

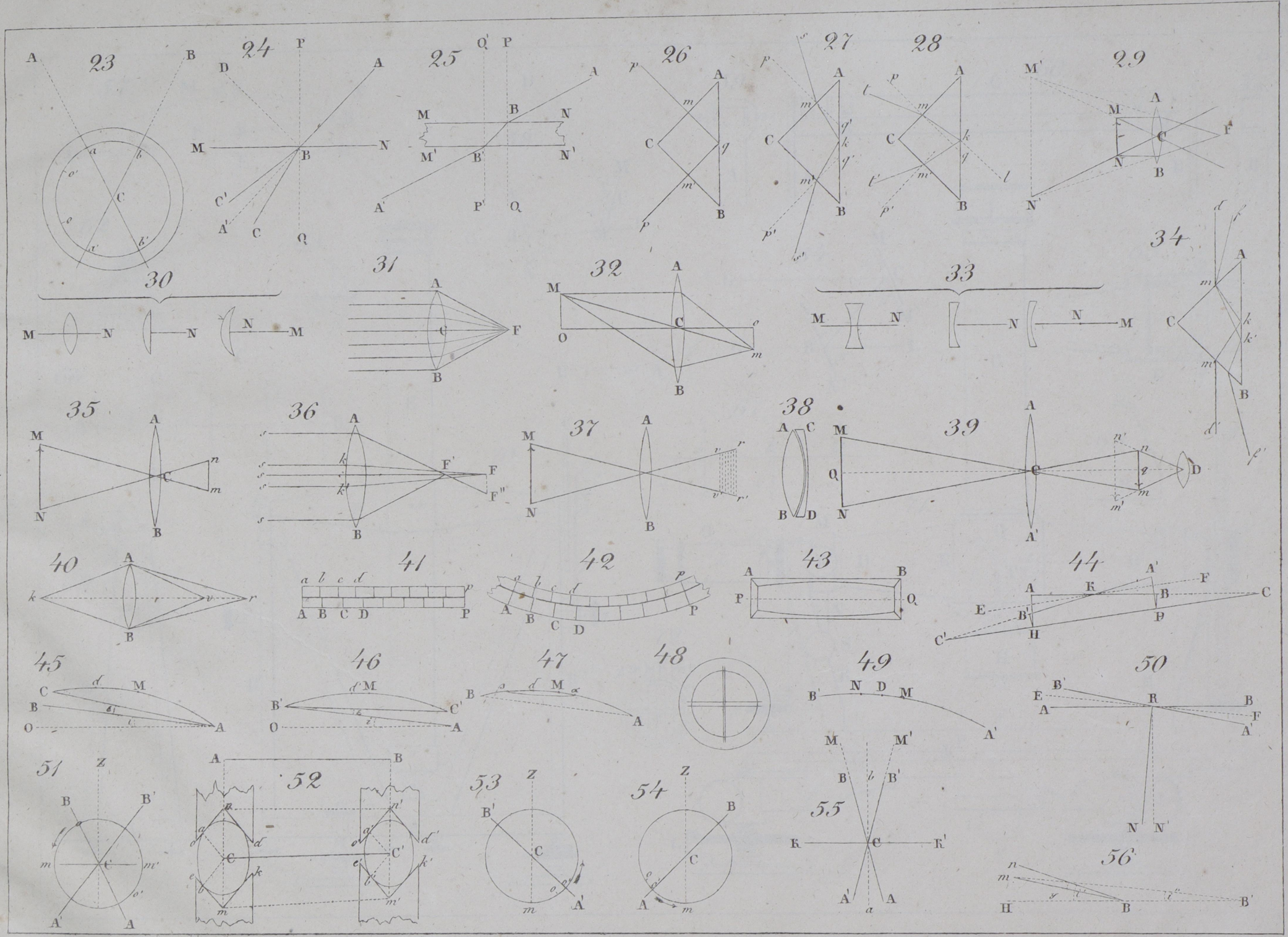

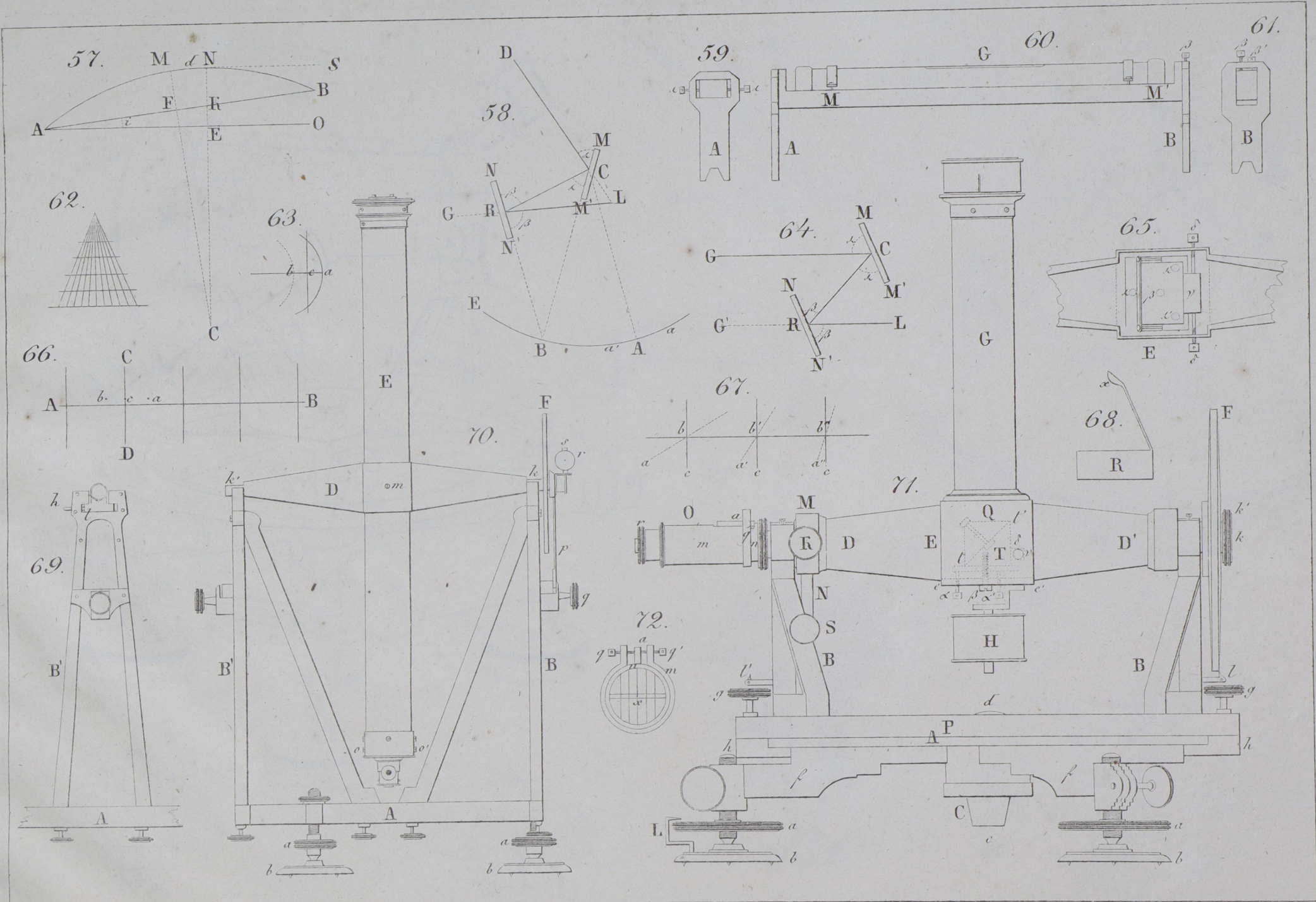

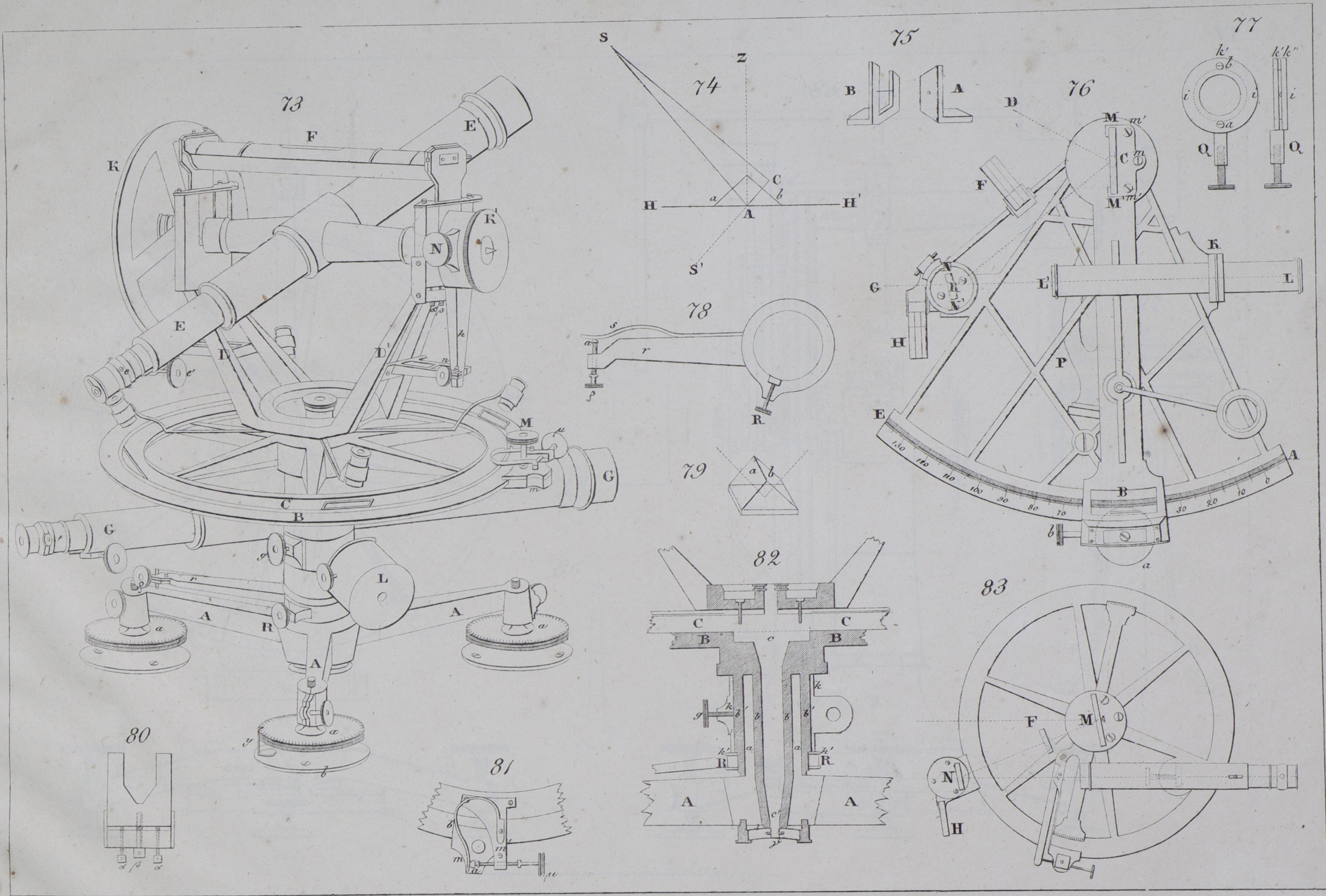

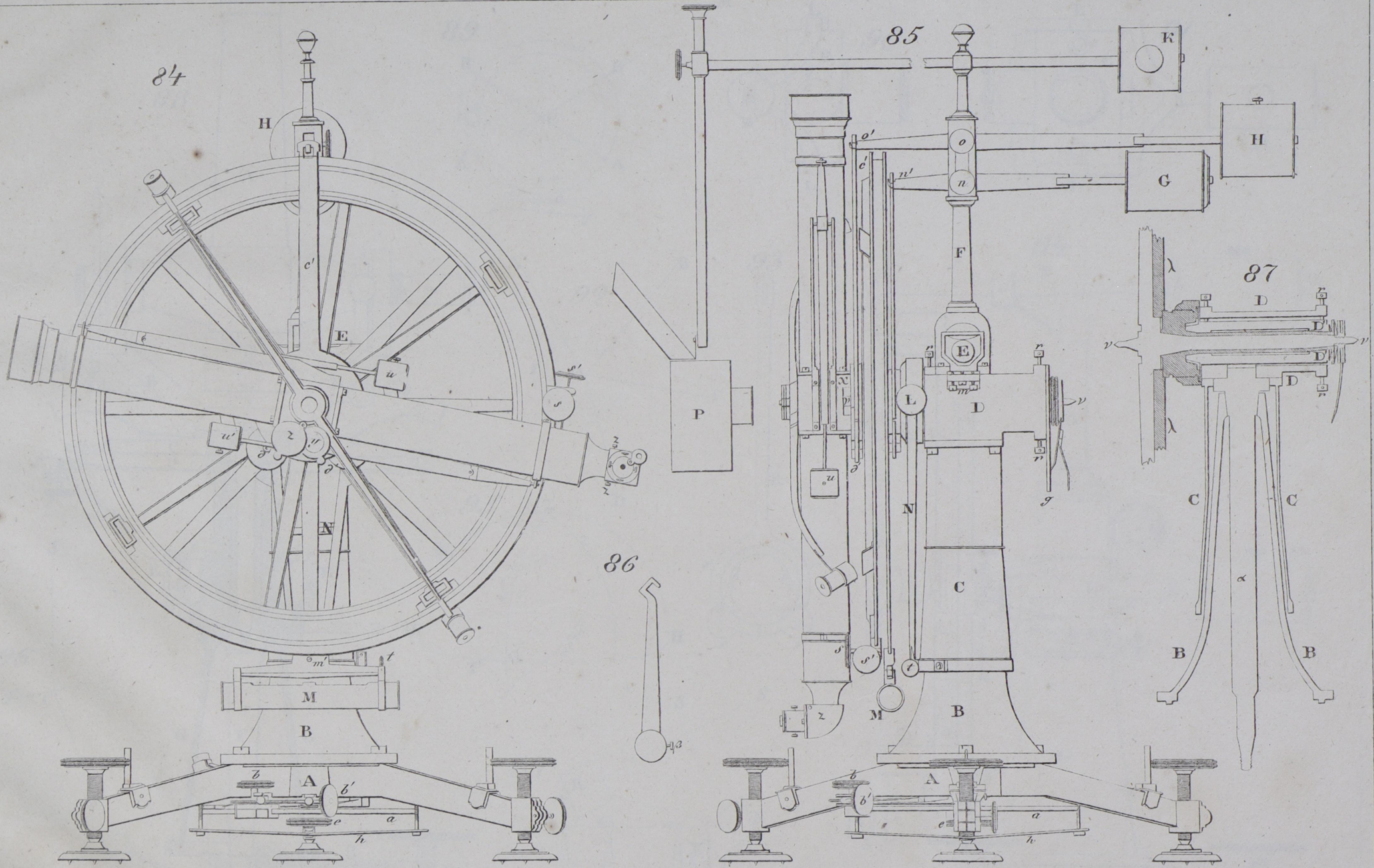

0 1 2 3 4 5 6 7 8 9 Шар. дюйм.

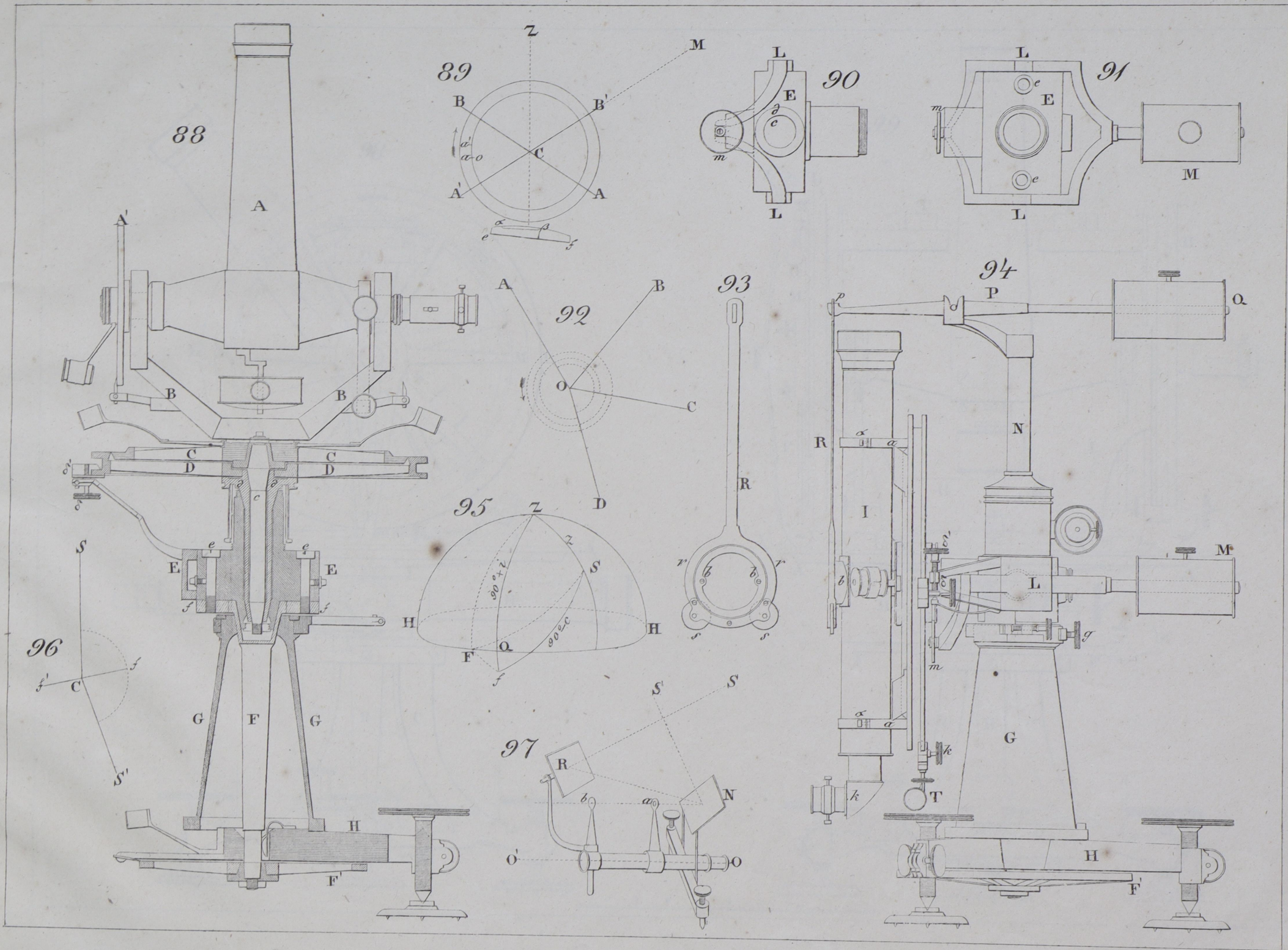

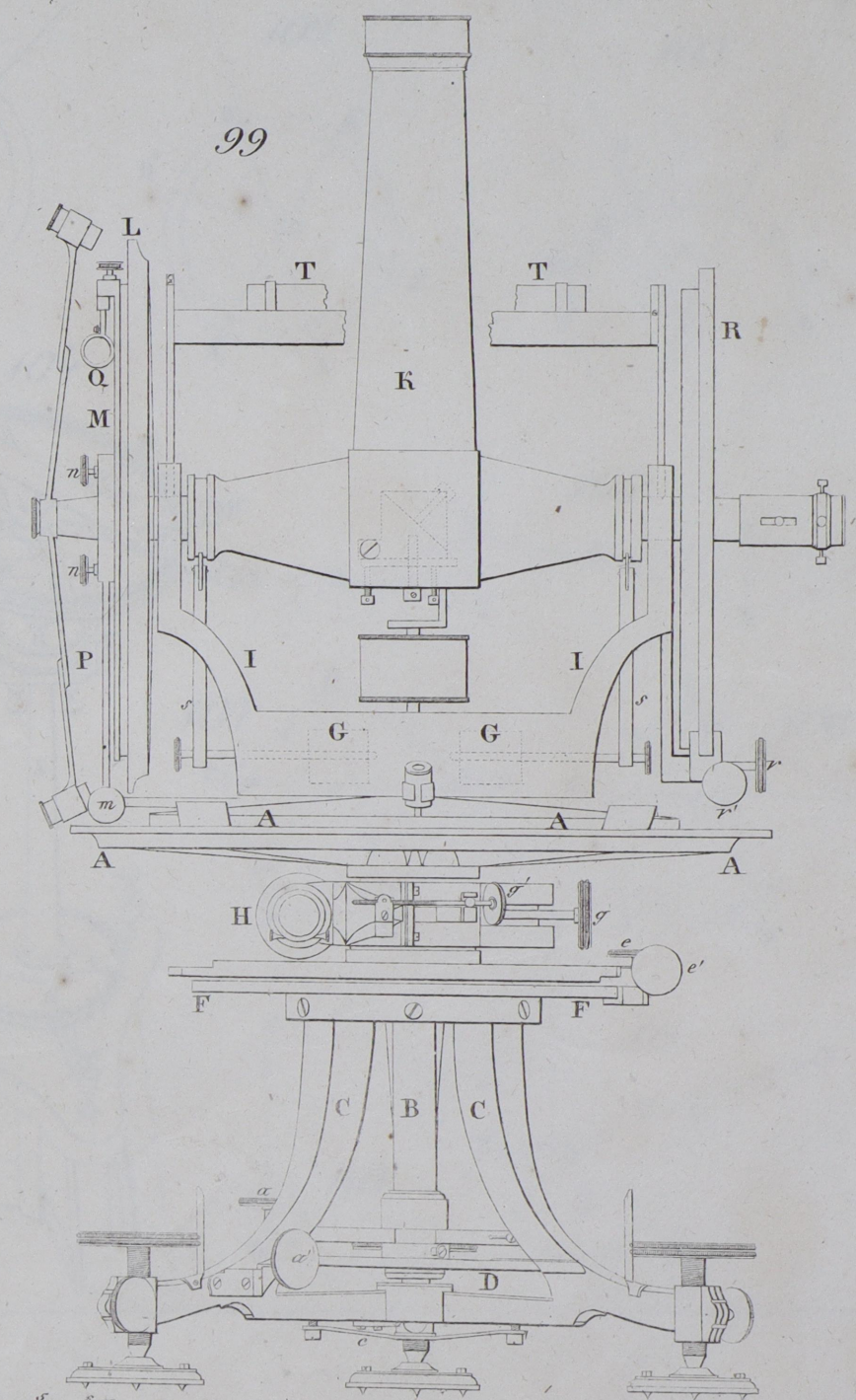
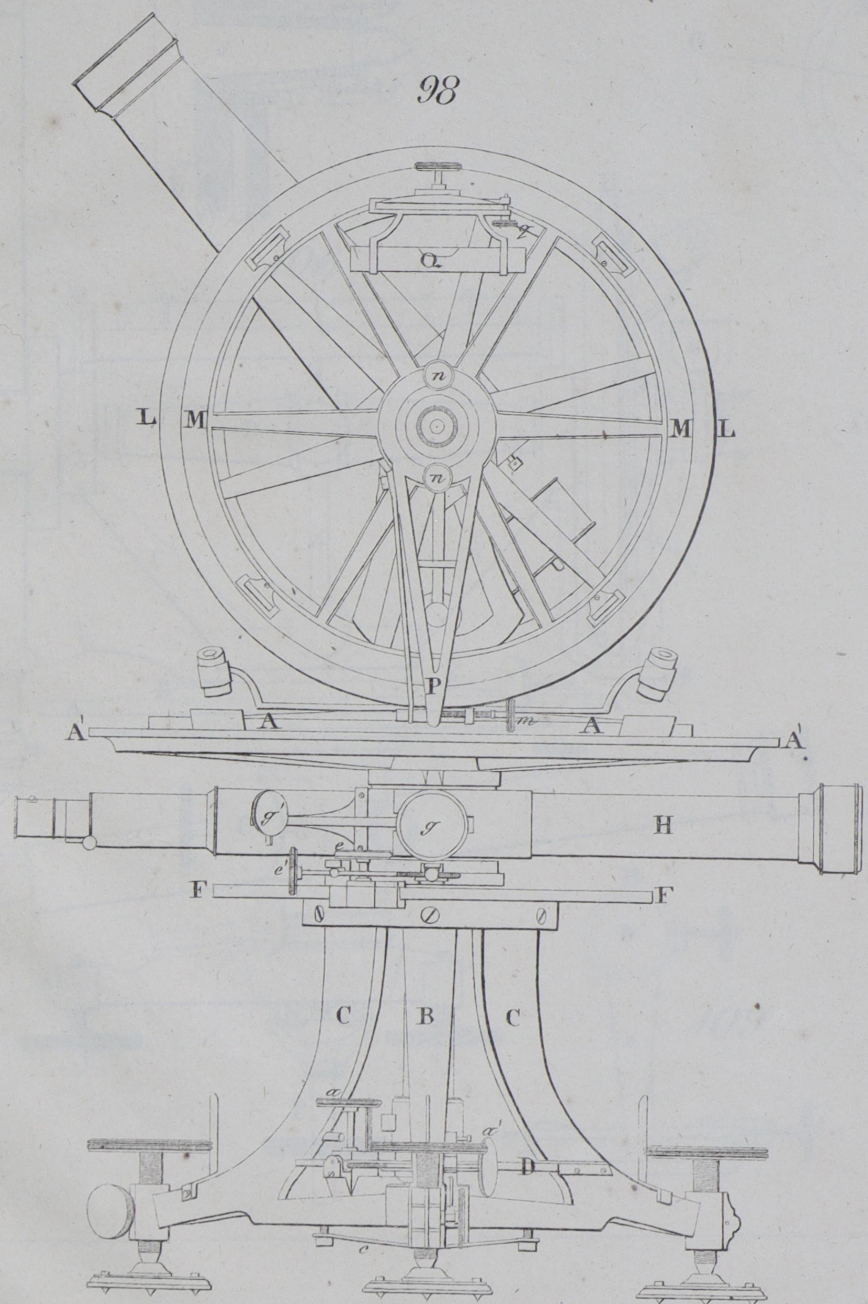

0 1 2 3 4 5
Первое дѣлѣн.

42990

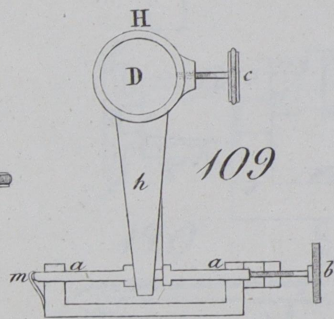
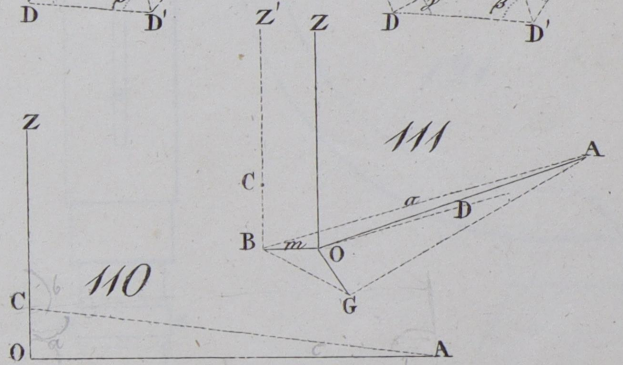
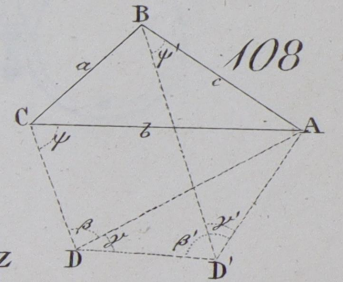
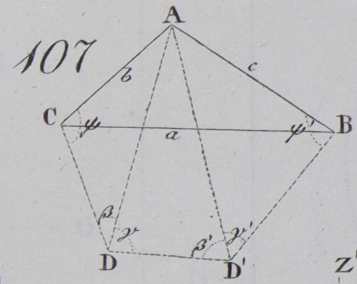
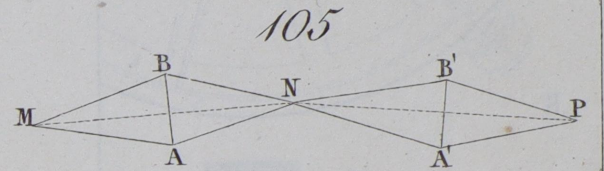
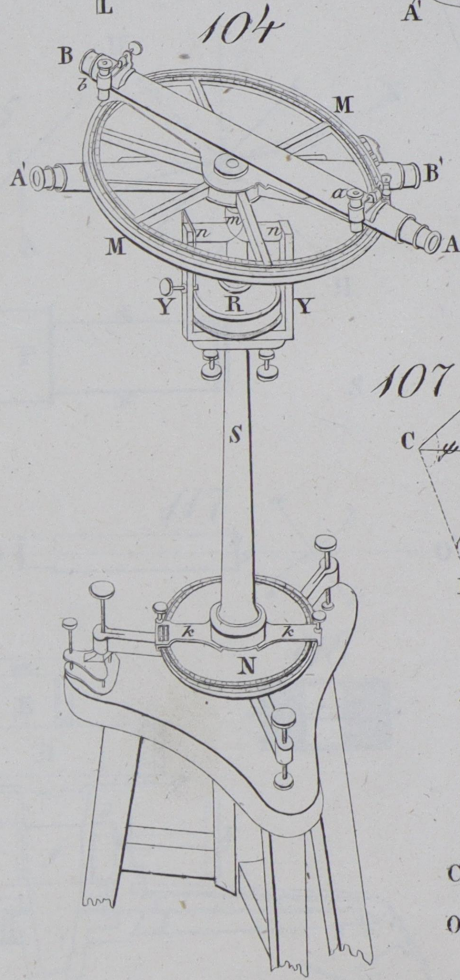
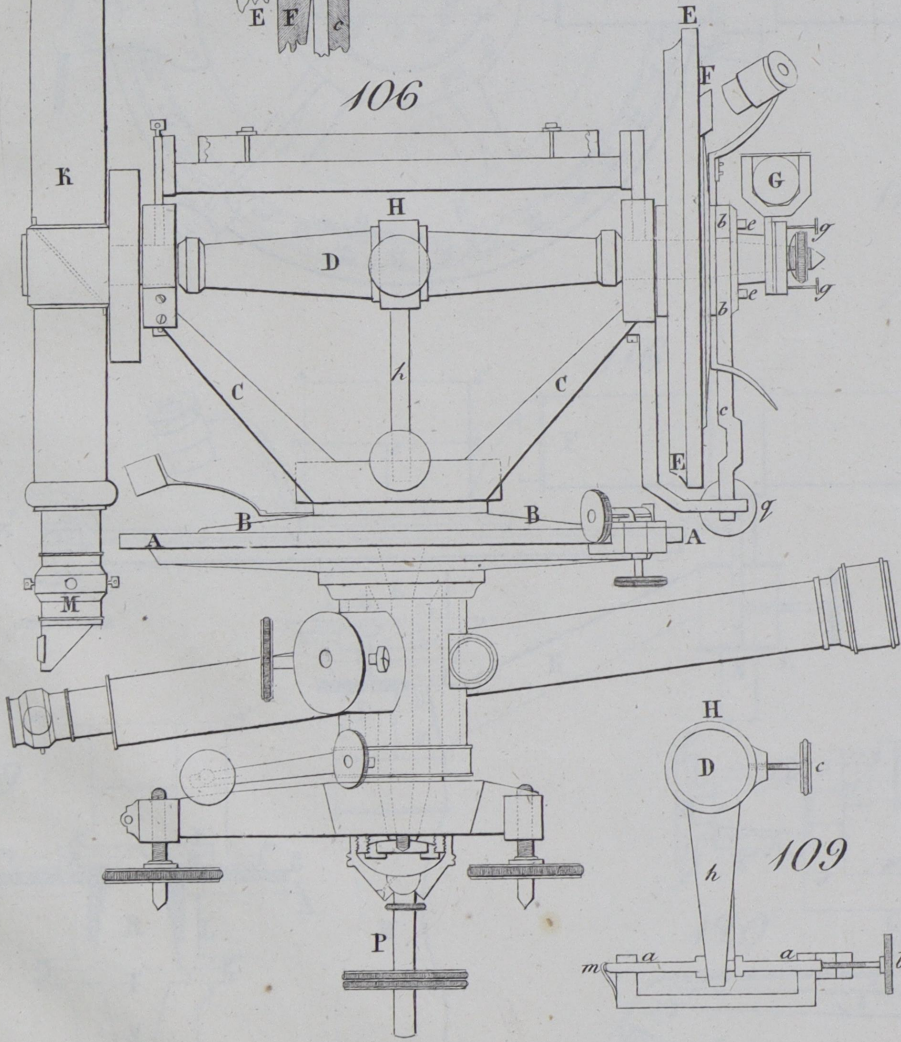
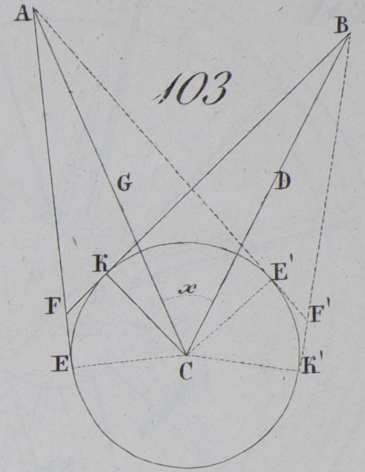
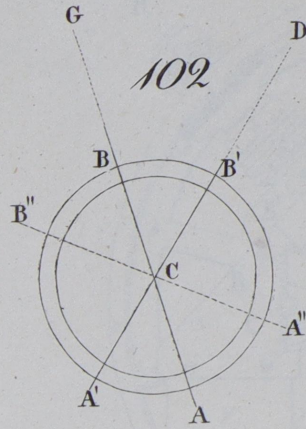
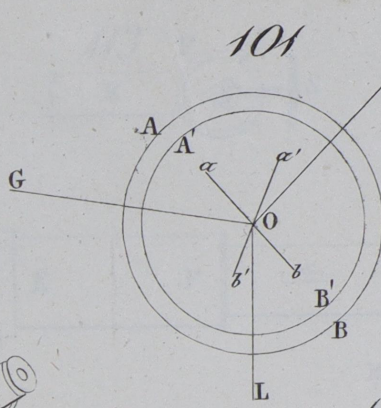
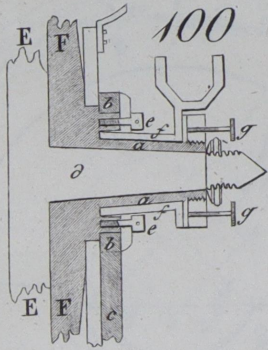

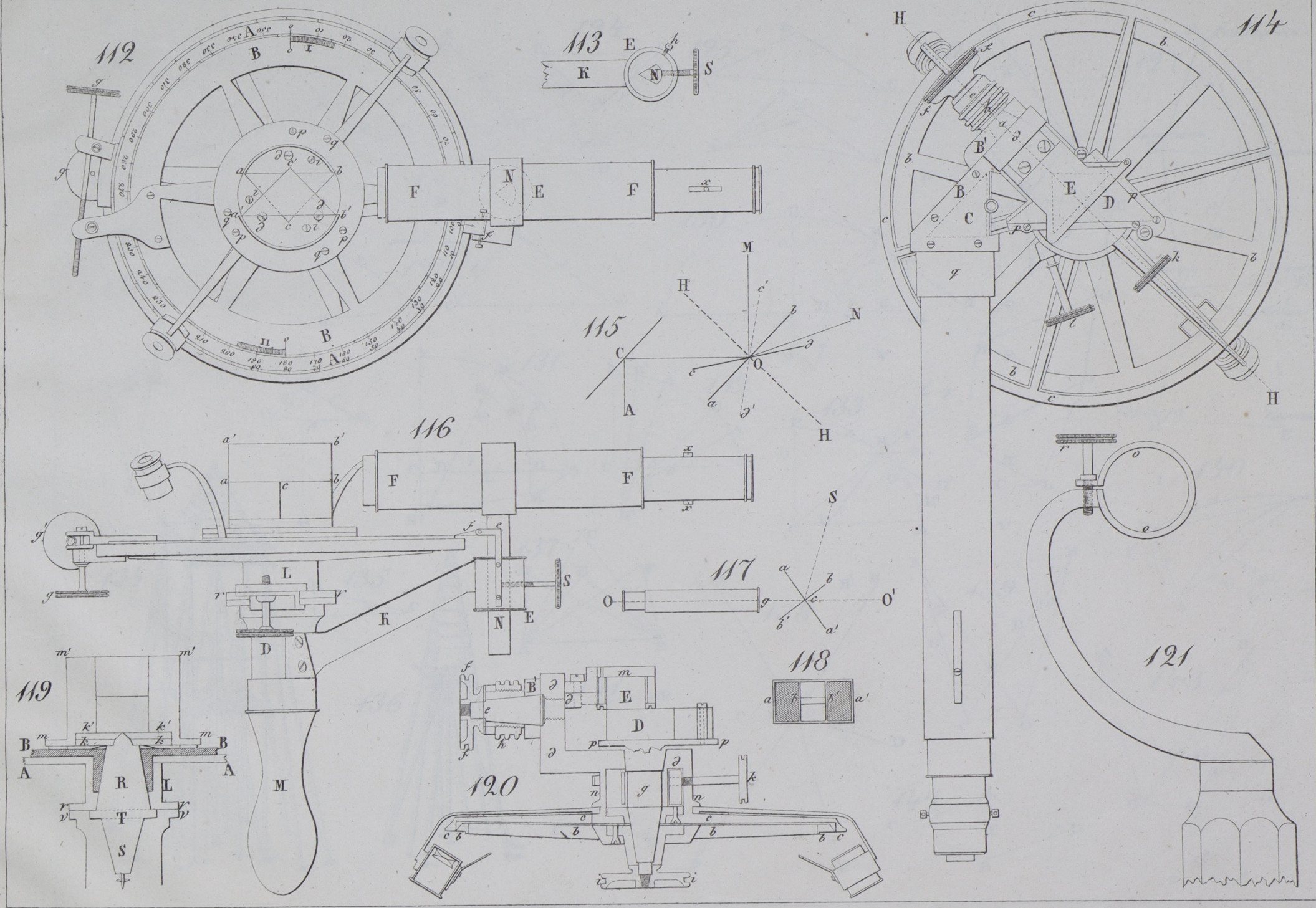

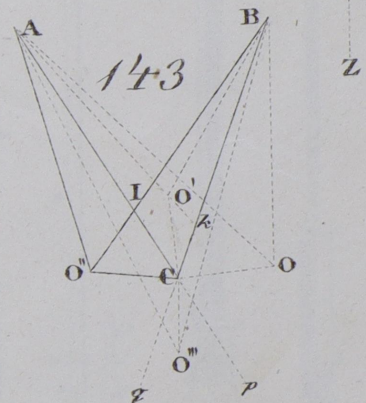
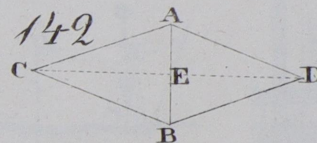
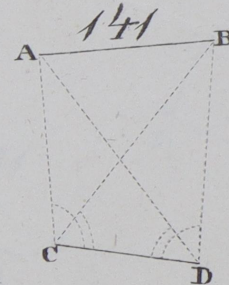
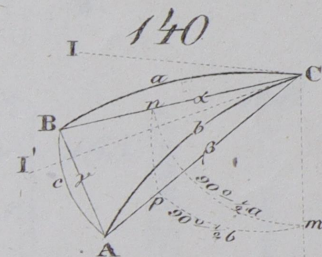
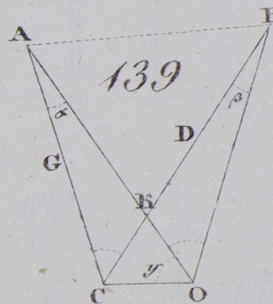
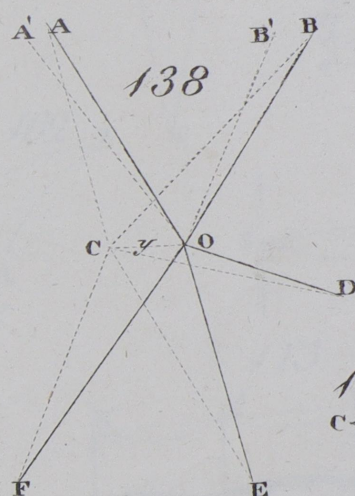
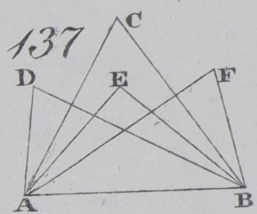
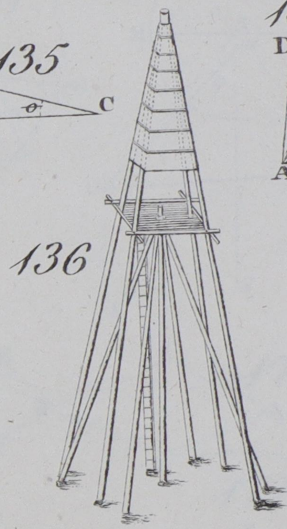
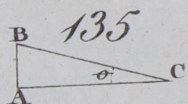
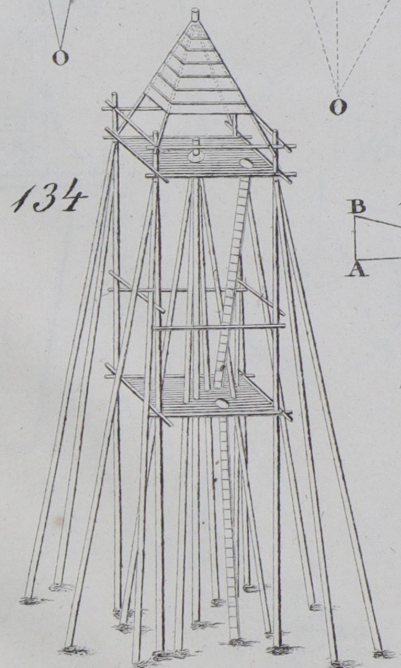
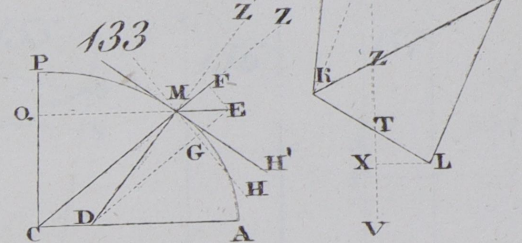
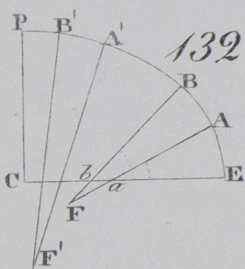
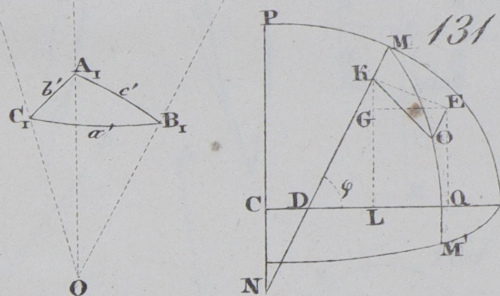
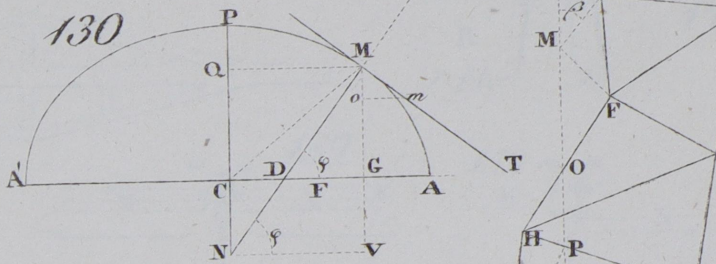
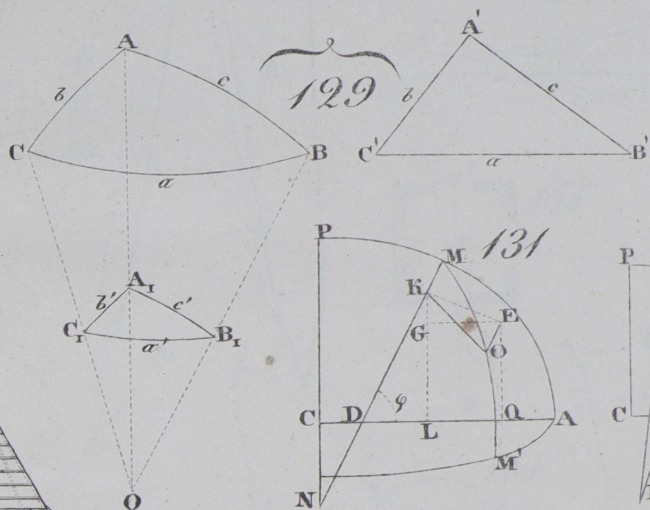
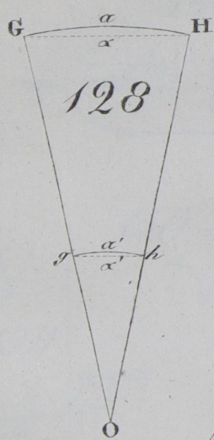
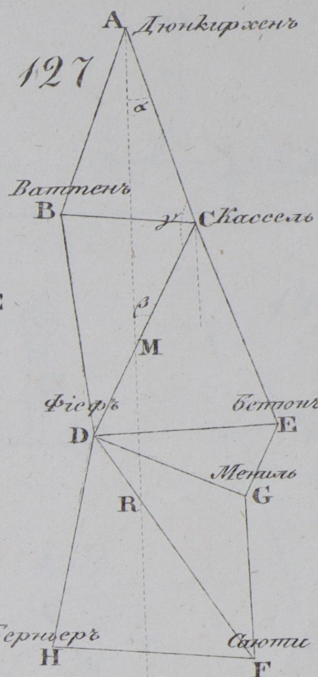
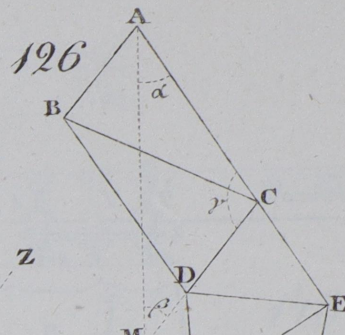
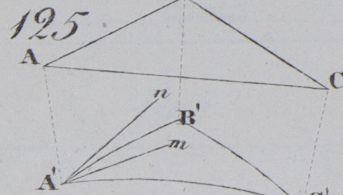
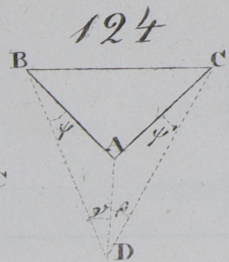
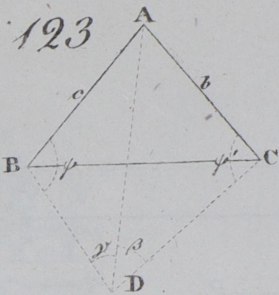
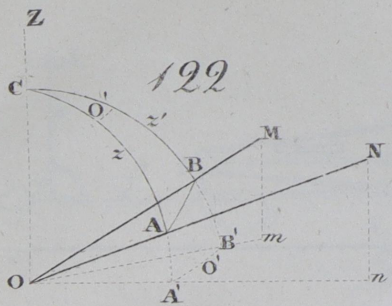

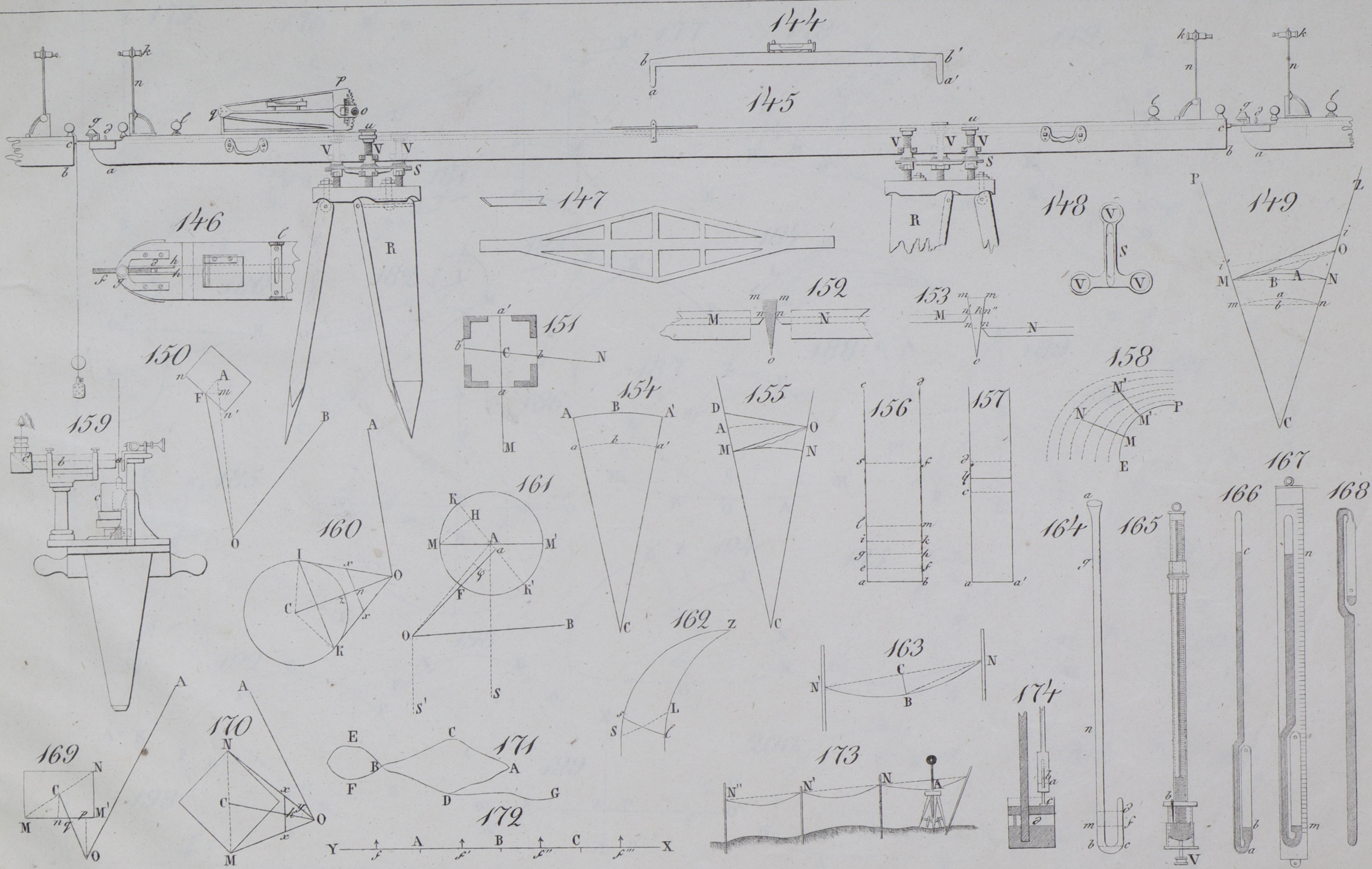

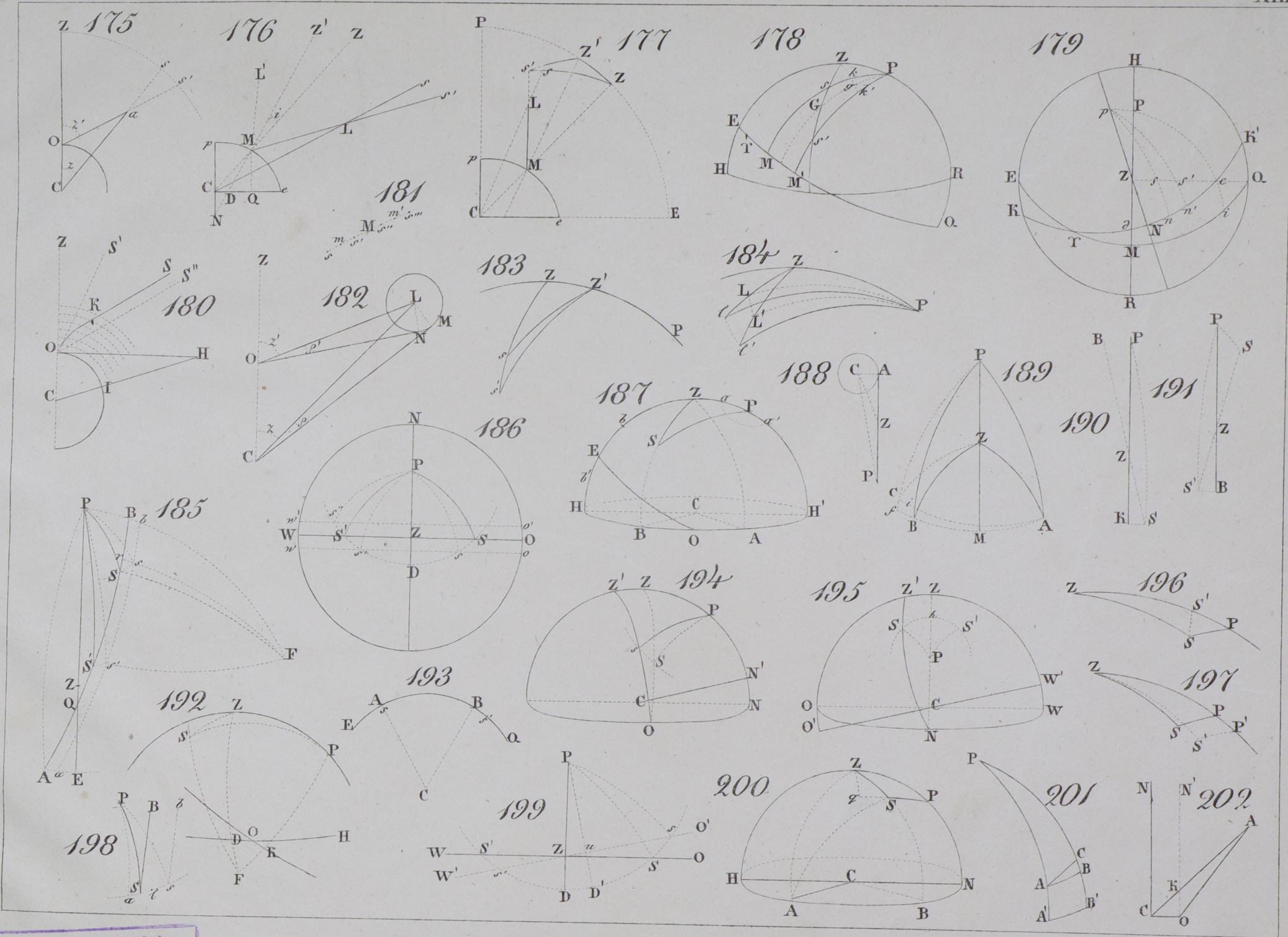

БИБЛИОТЕКА
 Белорусского
 института инженеров
 железнодорожного
 транспорта