

1.50/7+
069

РУКОВОДСТВО

КЪ КУРСУ

ПОДЪЕМНЫХЪ МАШИИЪ.

Составиль

А. Романовъ,

ИНЖЕНЕРЪ ПУТЕЙ СООБЩЕНІЯ.

ЧЕРТЕЖИ

КЪ ВЫПУСКУ ПЕРВОМУ

(ЛИСТЫ I—XX)



С.-ПЕТЕРБУРГЪ.

Типографія Министерства путей сообщенія (А. Бенке), Фонтанка 99.

1886.

1931

Абонемент № 2
Техническая библиотека
Дата 2004

621.86/7
P69

РУКОВОДСТВО

КЪ КУРСУ

ПОДЪЕМНЫХЪ МАШИНЪ.

29982

Составилъ

А. Романовъ,

ИНЖЕНЕРЪ ПУТЕЙ СООБЩЕНИЯ.

ЧЕРТЕЖИ

КЪ ВЫПУСКУ ПЕРВОМУ

(листы I—XX)

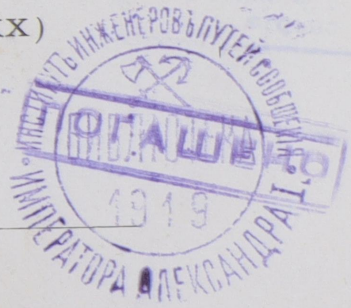

Даръ проф. А. А. БРАНДТА.

С.-ПЕТЕРБУРГЪ.

Типографія Министерства путей сообщенія (А. Бенке), Фонтанка 99.
1886.

1975

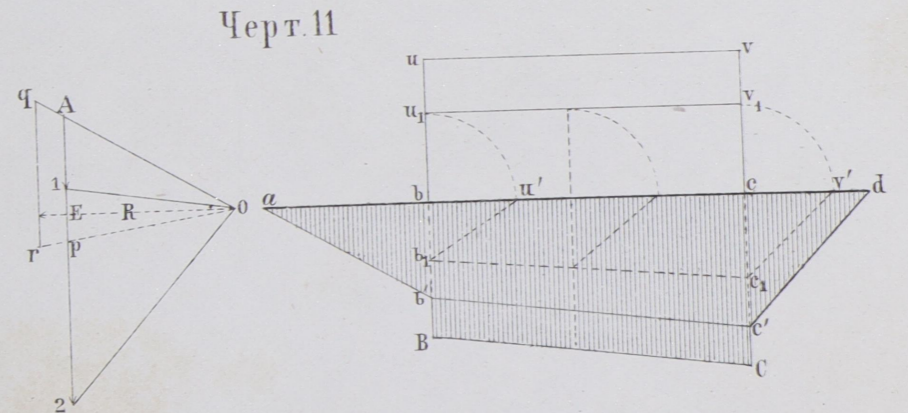
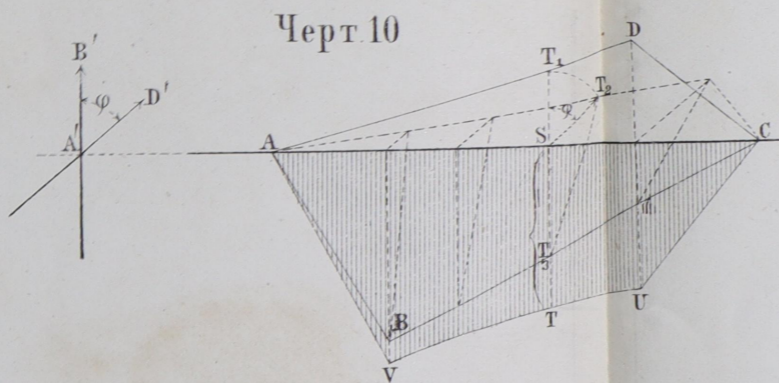
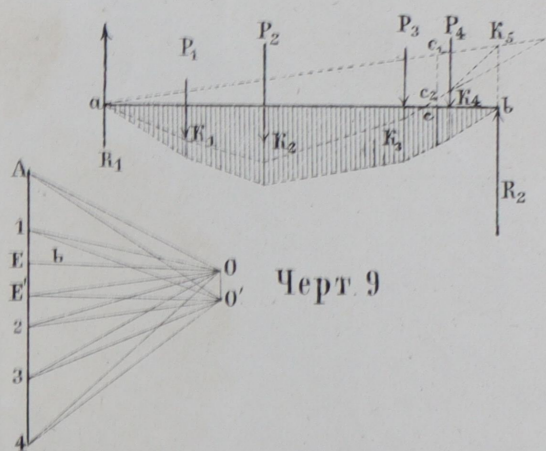
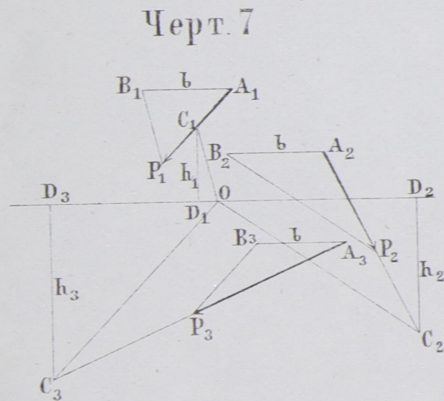
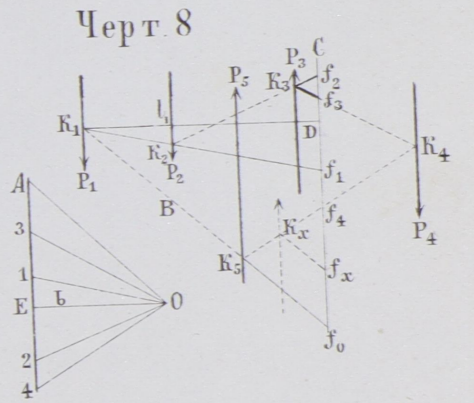
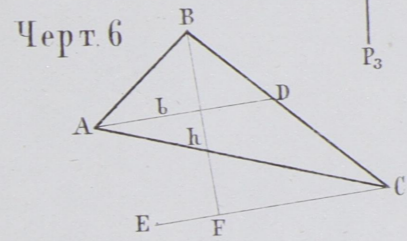
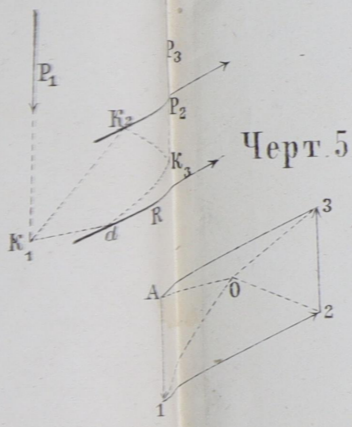
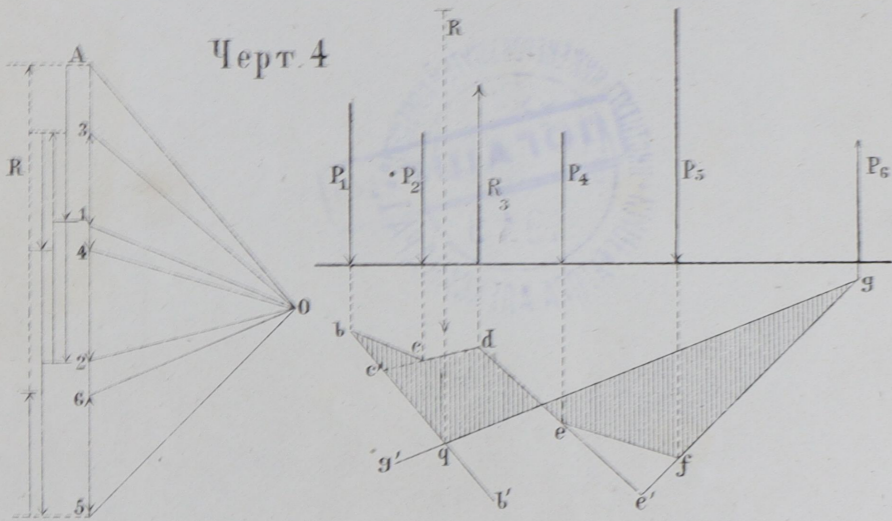
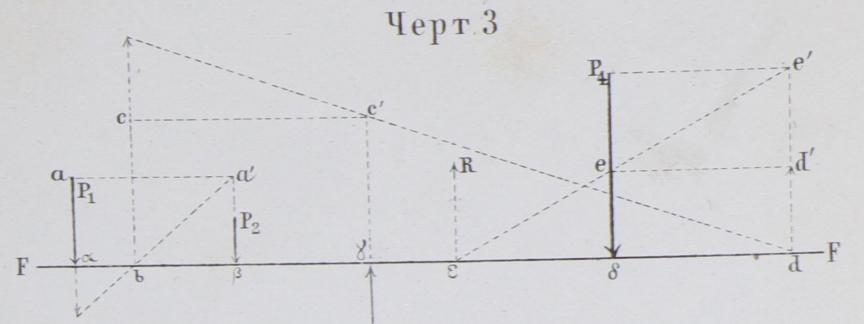
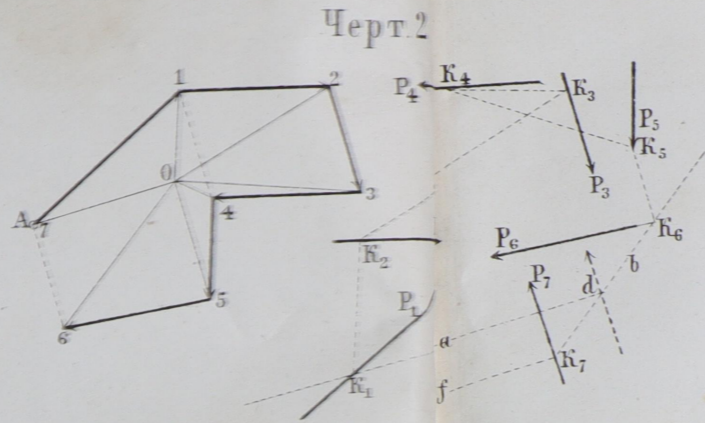
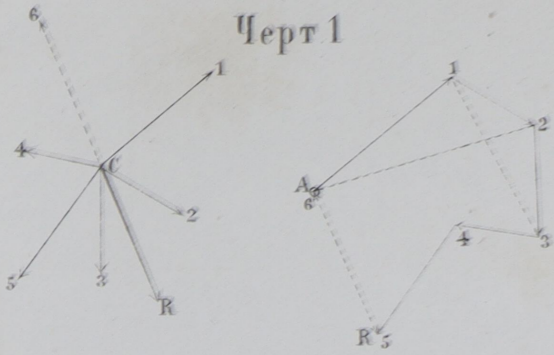

Черт. 12

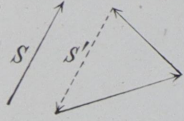

Черт. 13

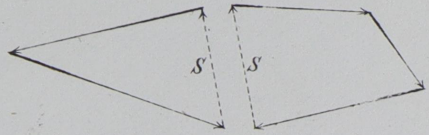

Черт. 14

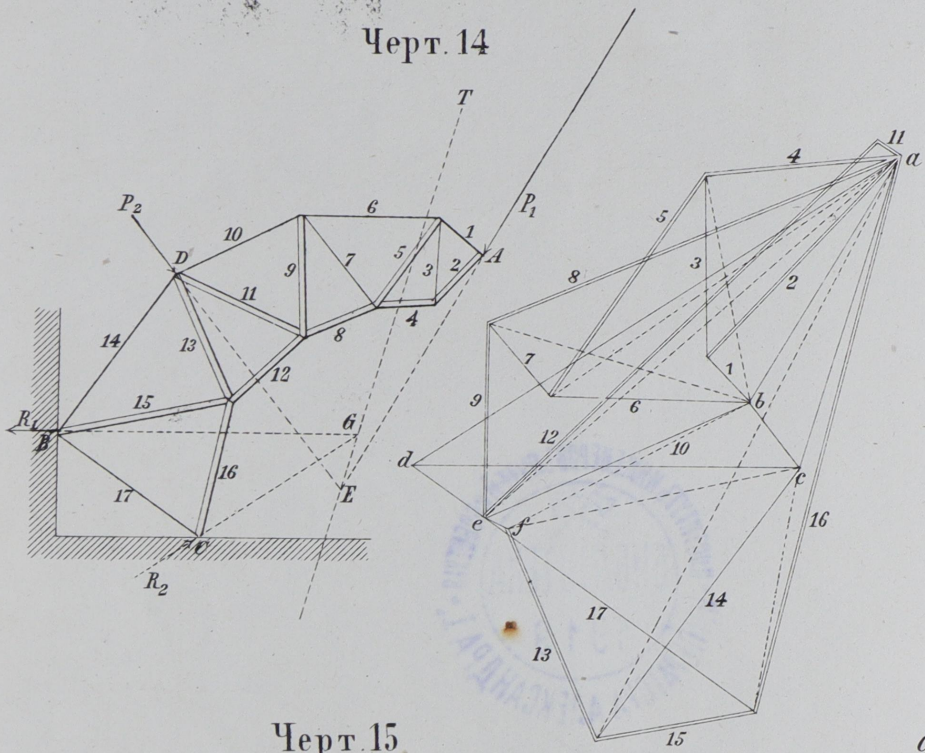

Черт. 15

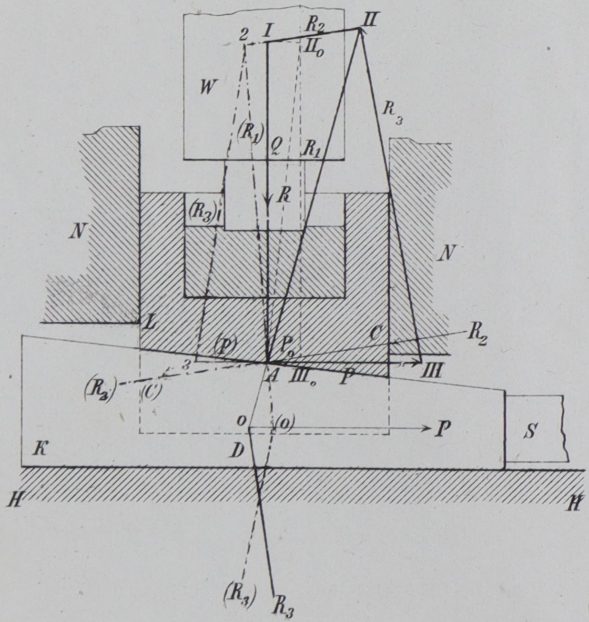

Черт. 16

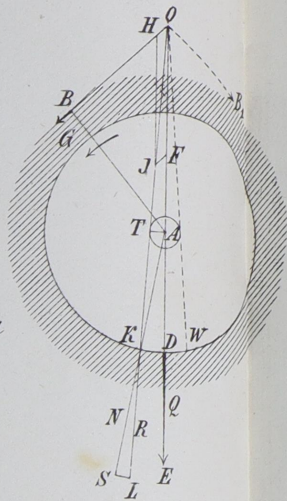

Черт. 17

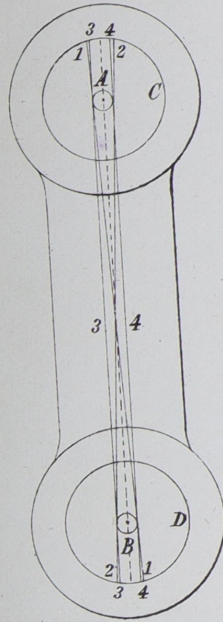

Черт. 19

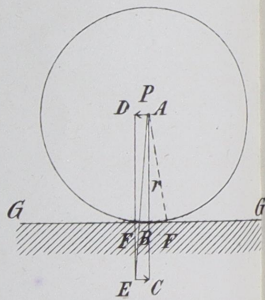

Черт. 20

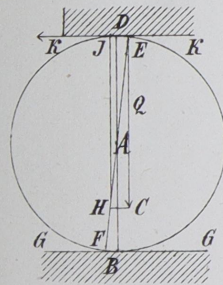

Черт. 21

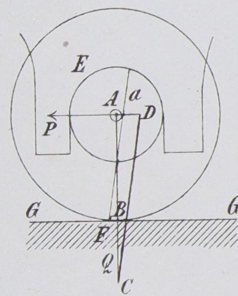

Черт. 18

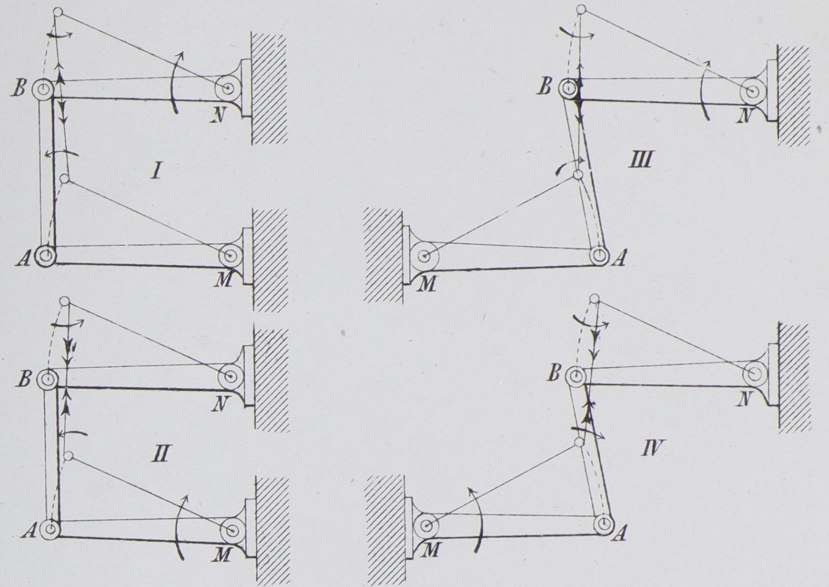

Черт. 22

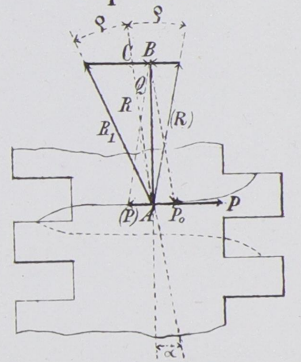

Черт. 23

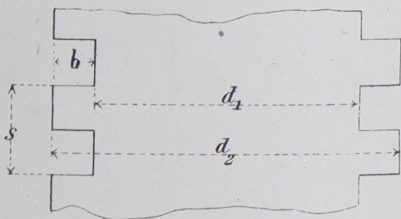

Черт. 24

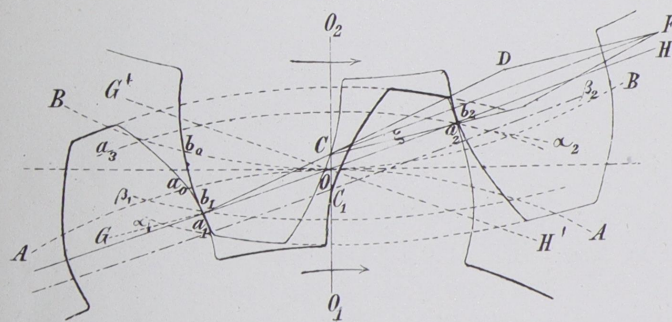

Черт. 25

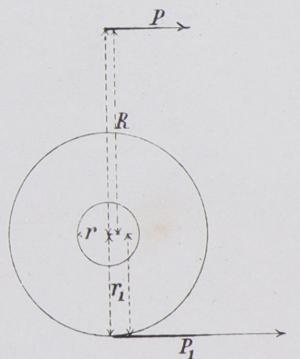

Чер 26

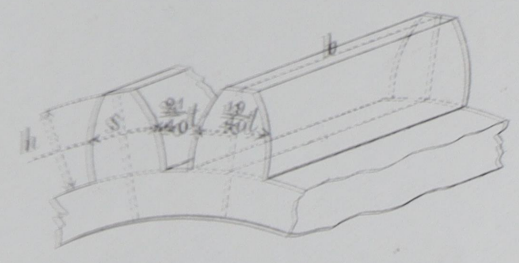

Чер 27

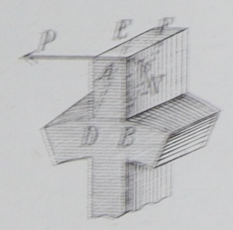

Чер 28

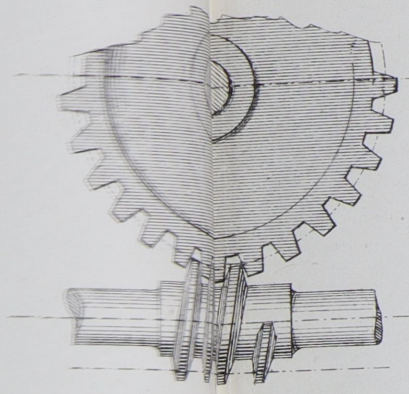

Чер 29

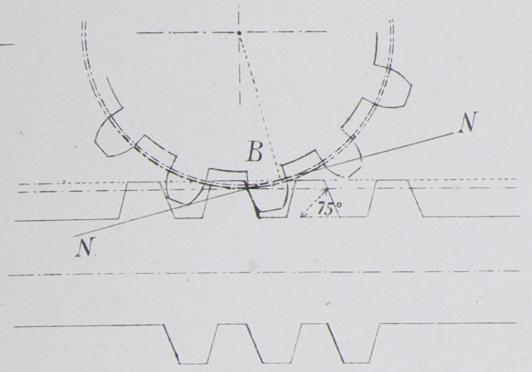

Чер 30

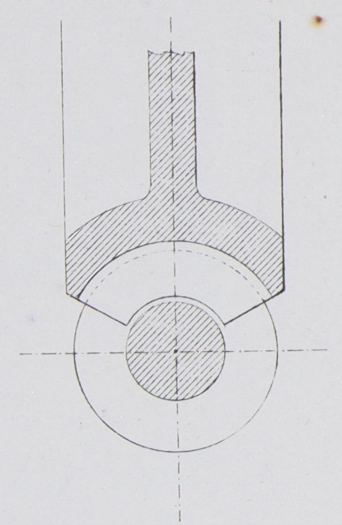

Чер 31

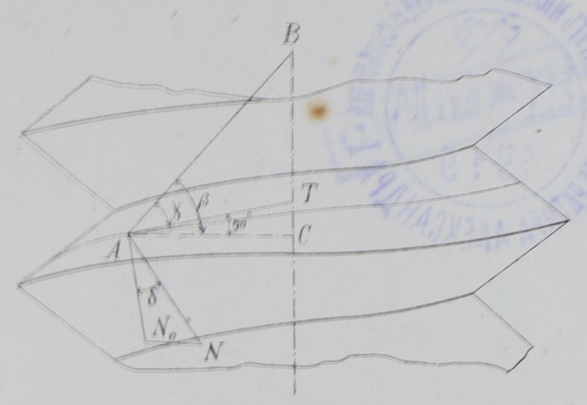

Чер 32

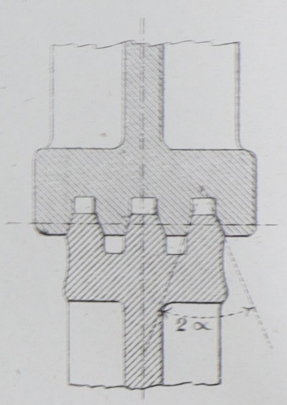

Чер 33

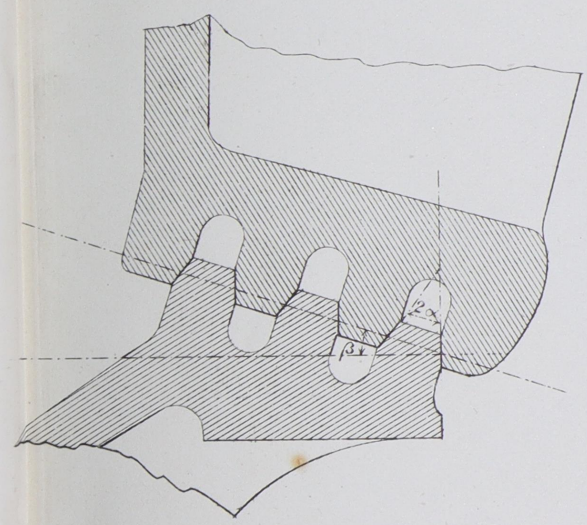

Чер 34

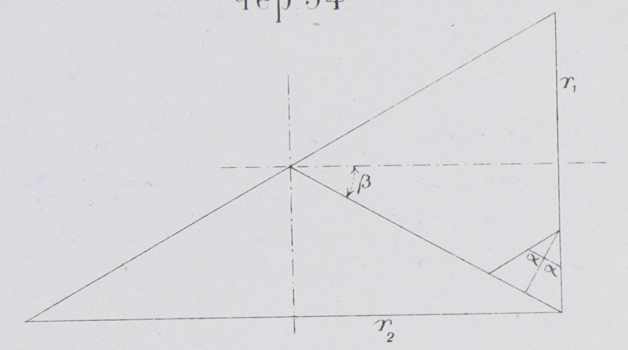

Чер 35

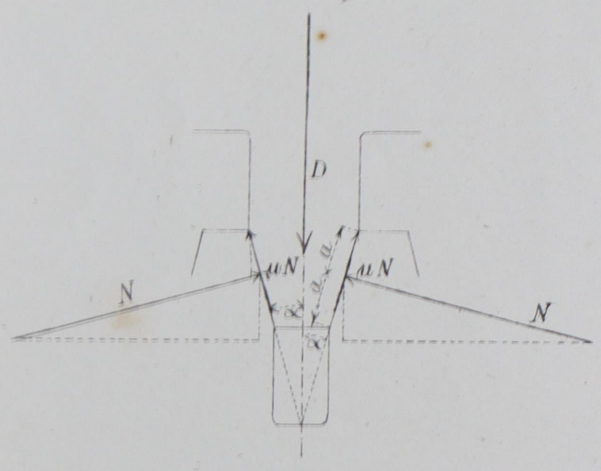

Чер 36

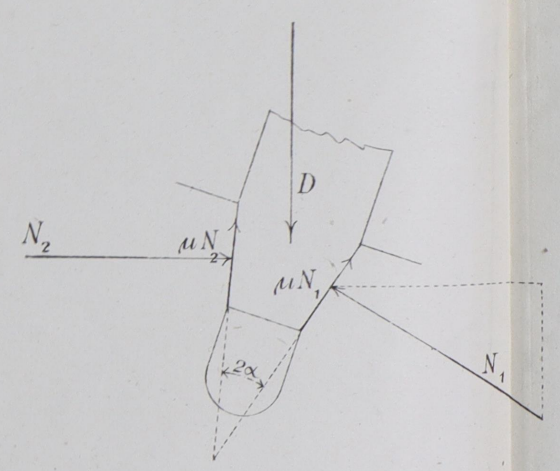

Чер 37

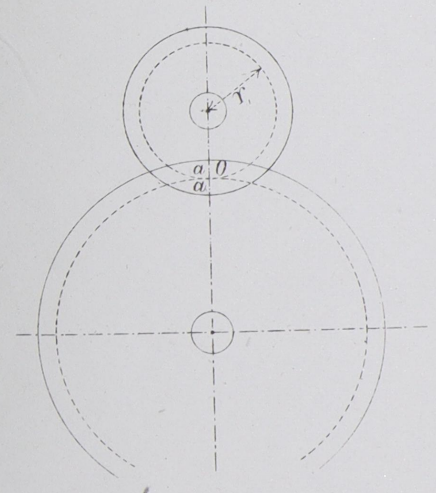

Чер 38

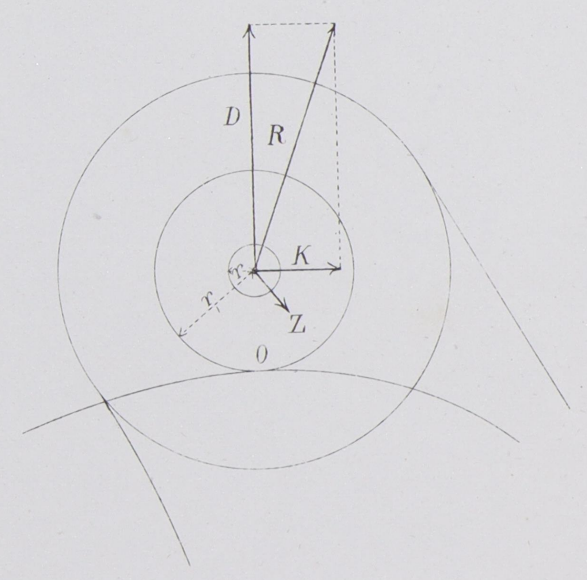

Чер 39

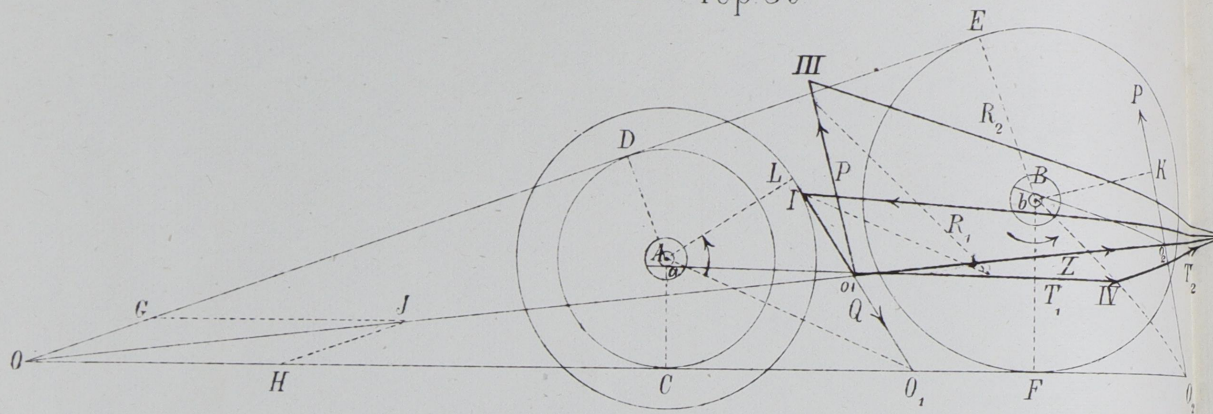

Чер 40

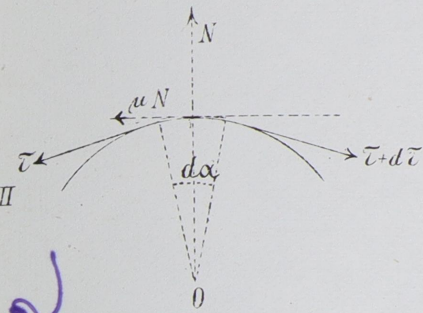

Чер 41

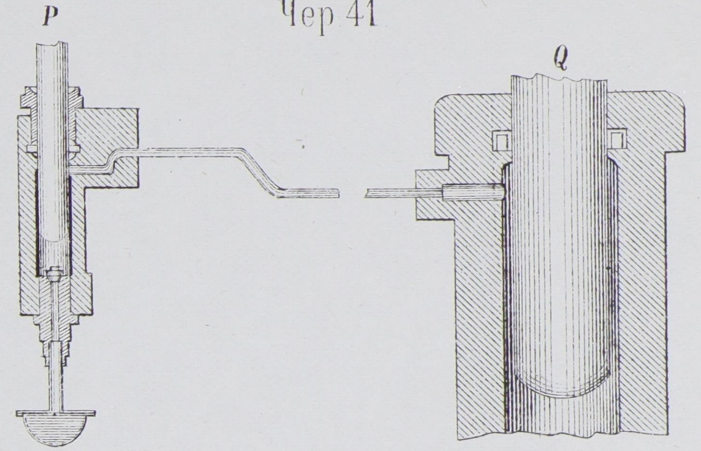

Чер 42

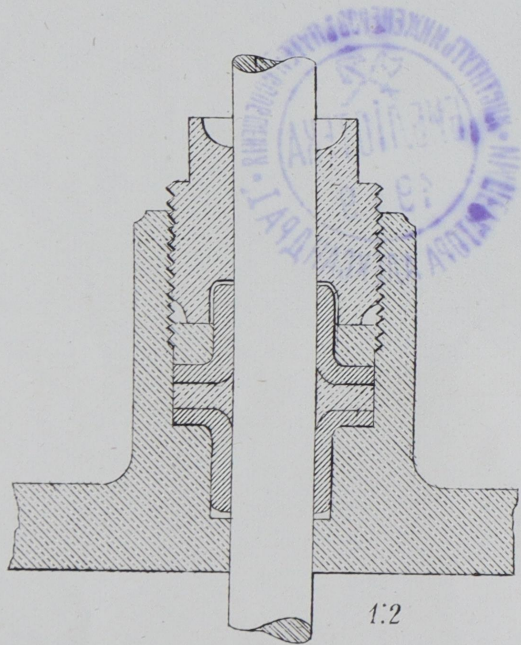

Чер 44

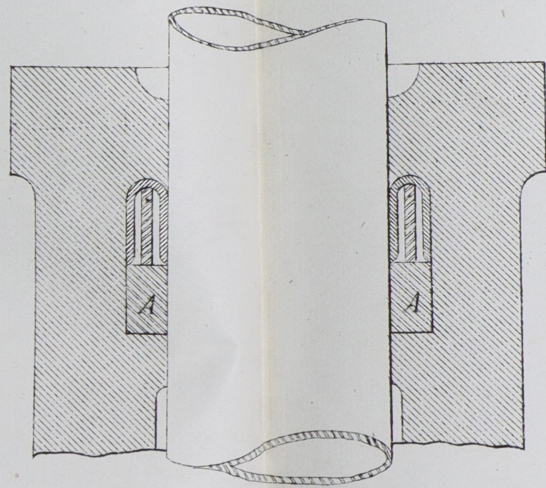

Чер 45

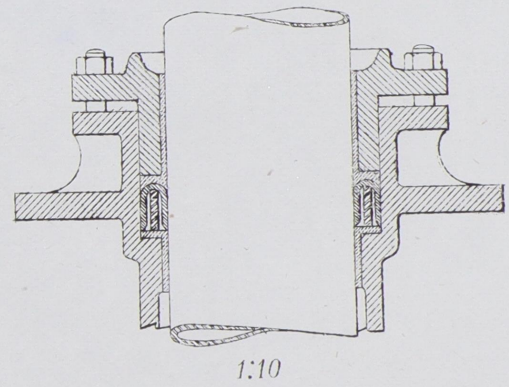

Чер 46

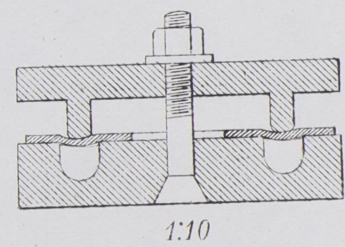

Чер 43

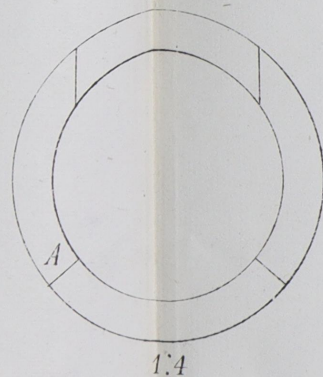
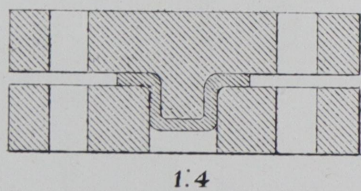

1:4

Черт. 47

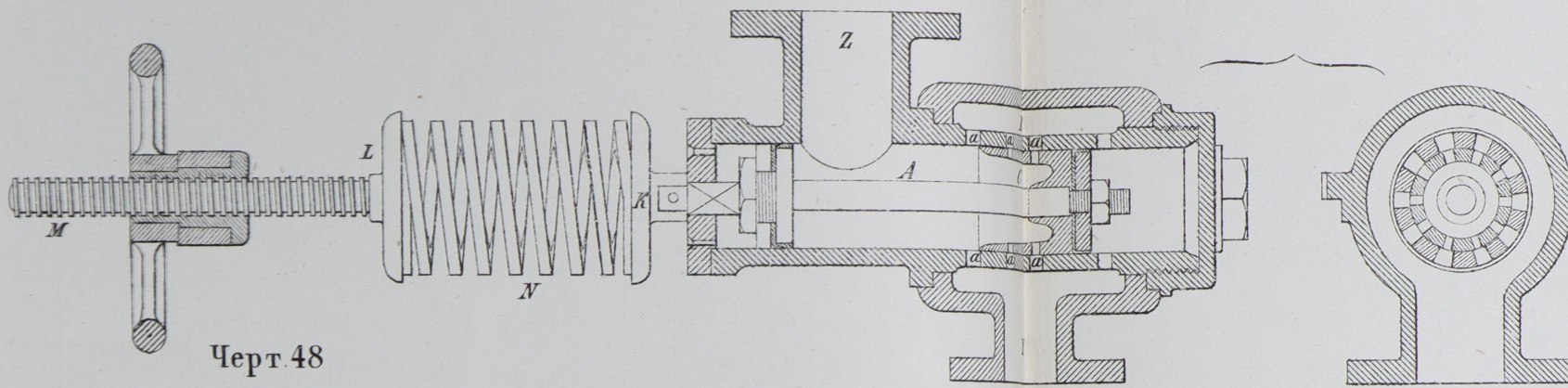

Черт. 49

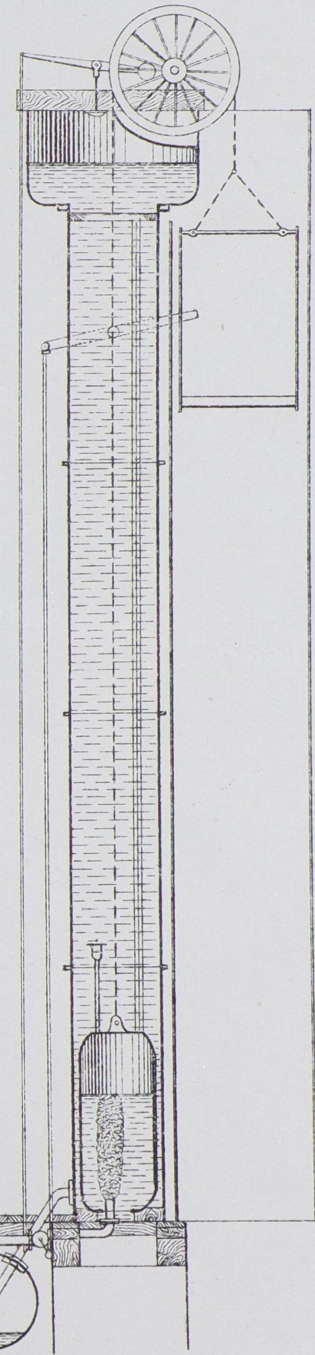

Черт. 48

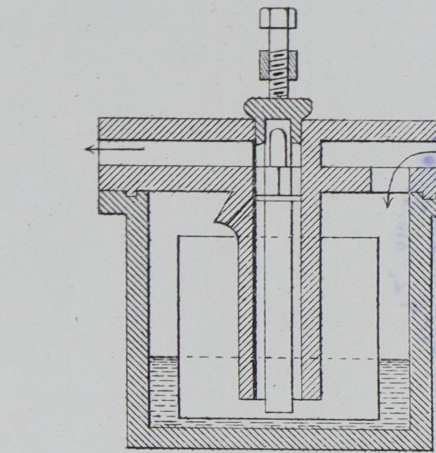

Черт. 51

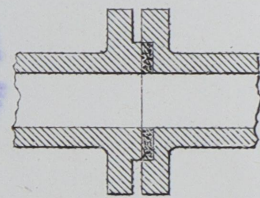

Черт. 52

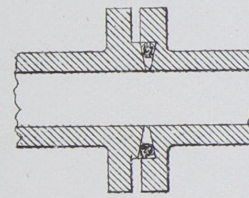

Черт. 53

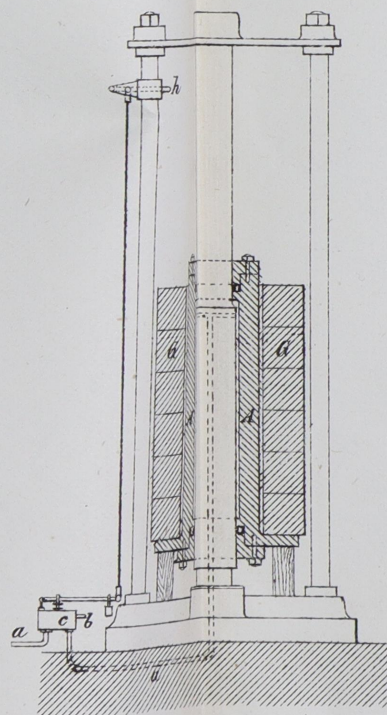

Черт. 50

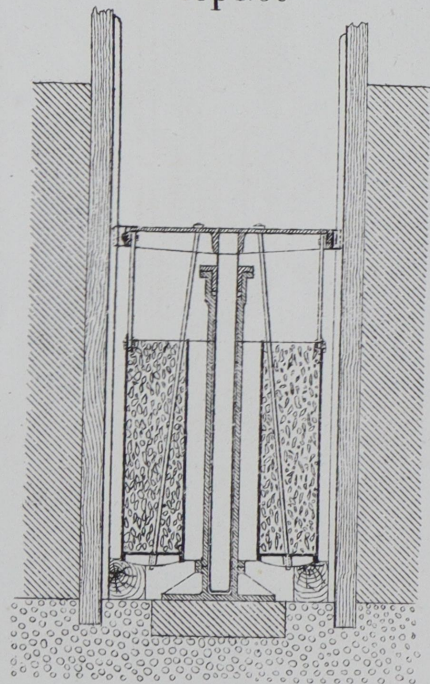

Черт 54

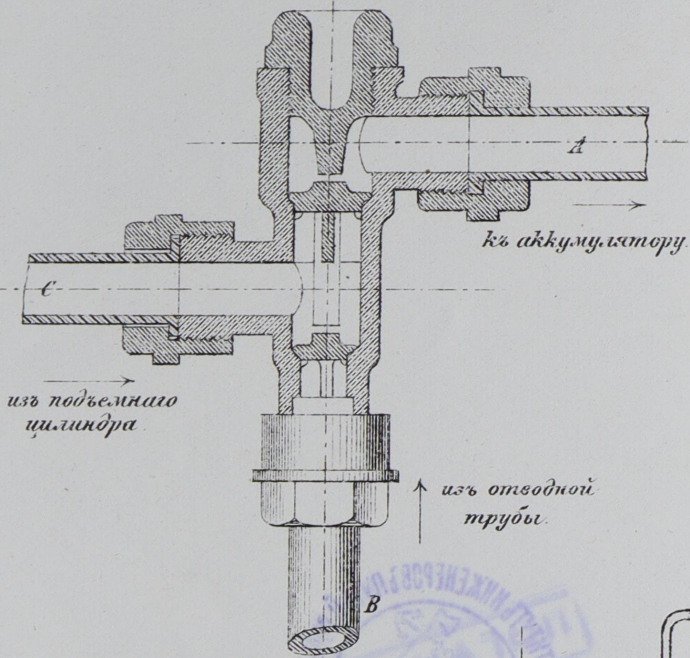

Черт 56

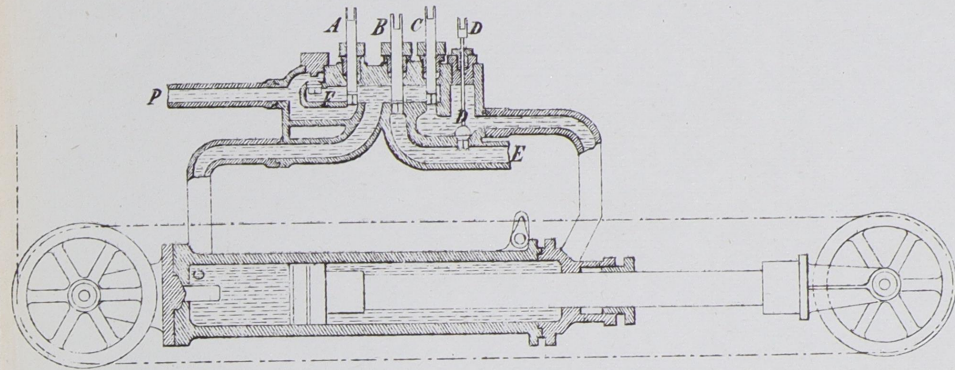

Черт 57

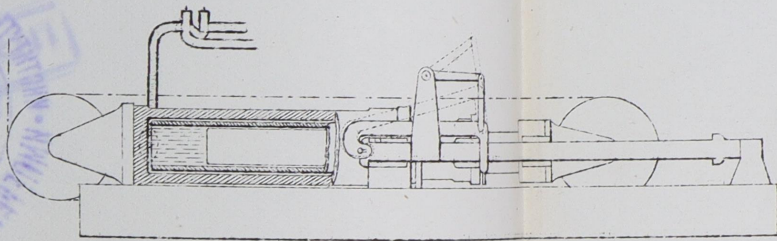

Черт 55

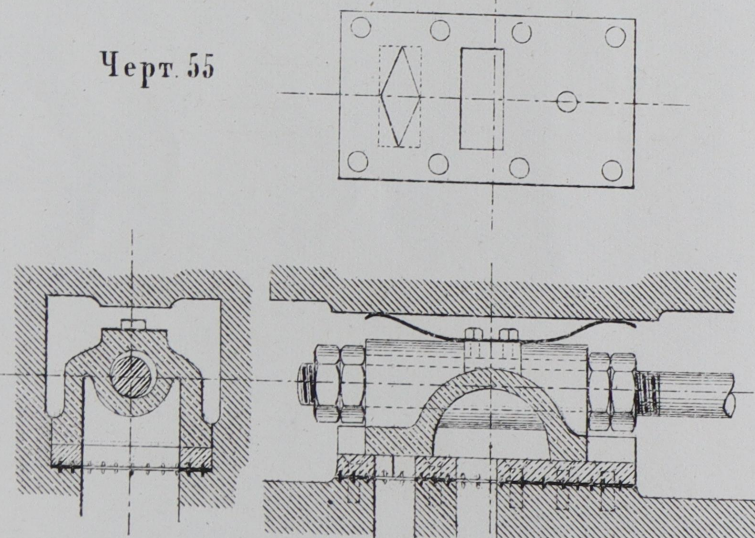

Черт 60

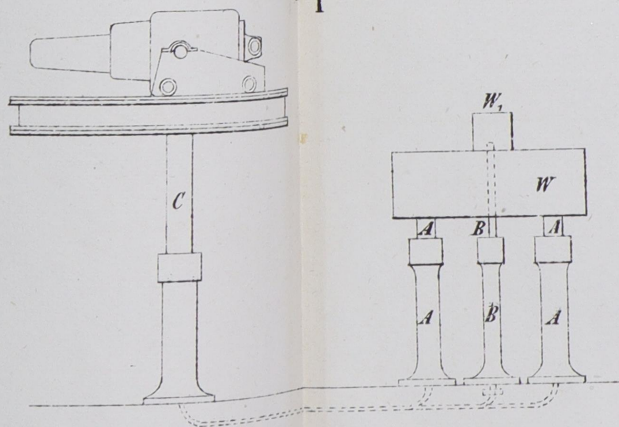

Черт 58

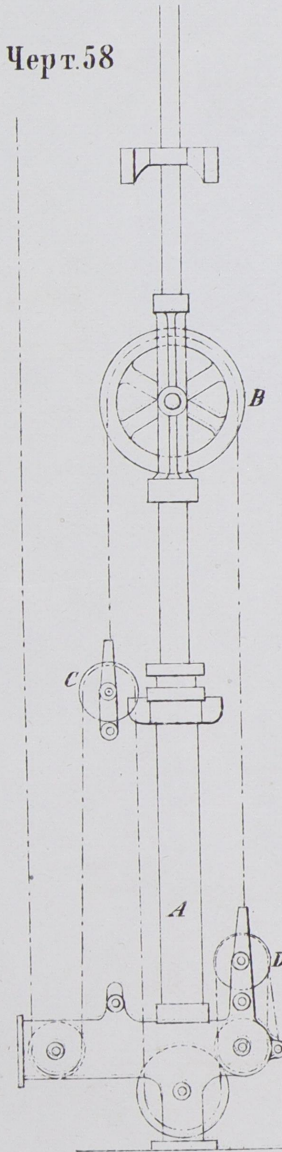

Черт 59

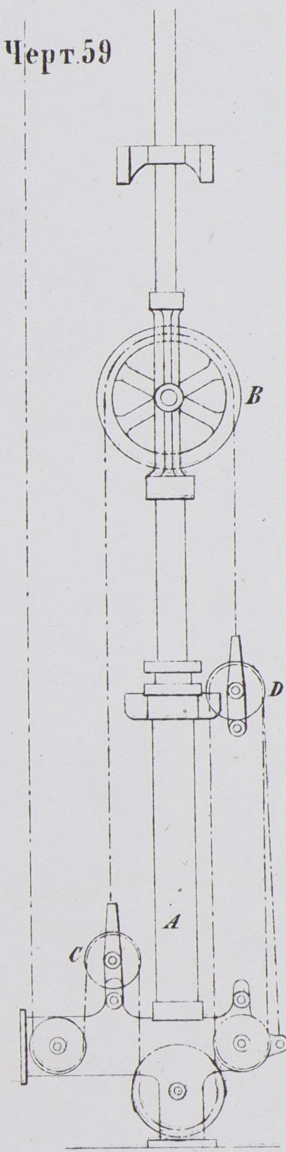

Черт. 61

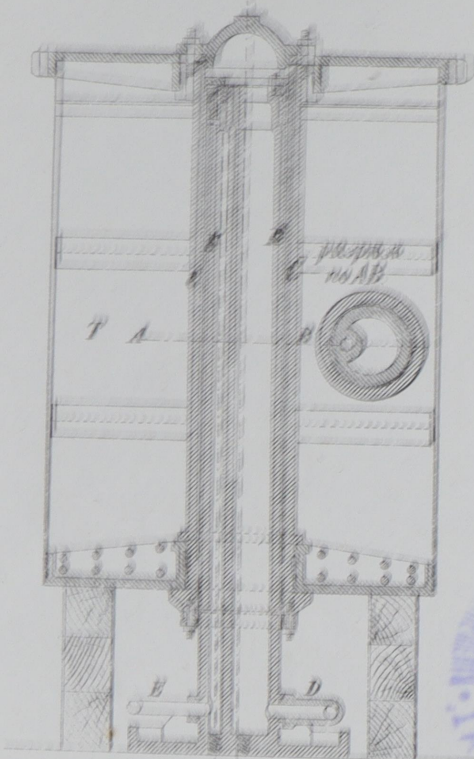

Черт. 62

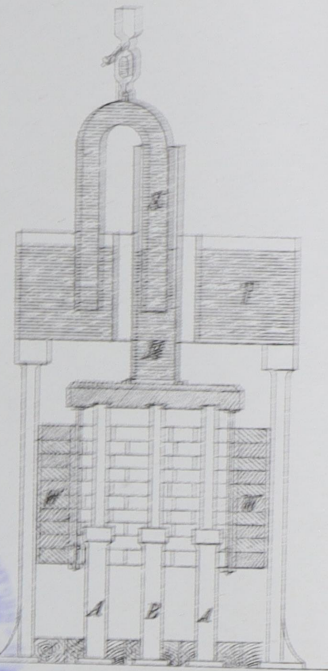

Черт. 63

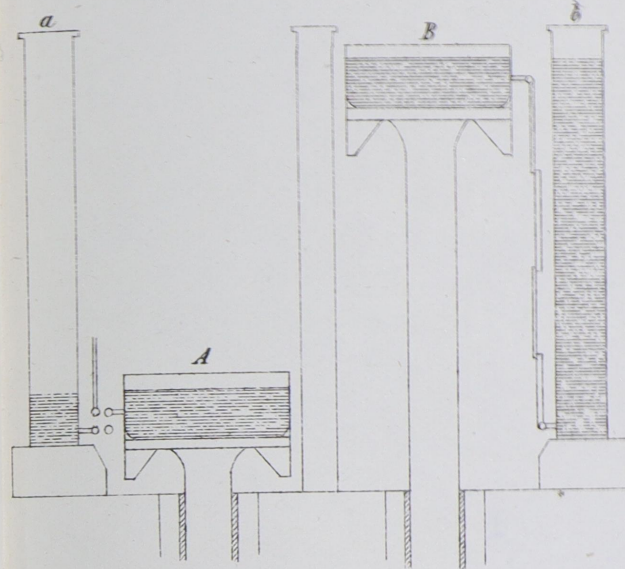

Черт. 65

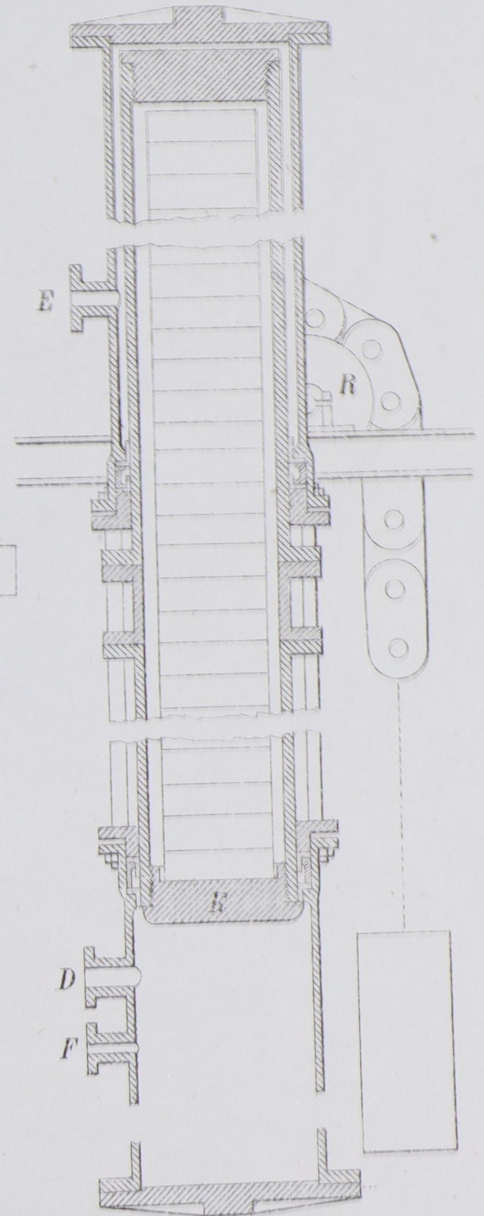

Черт. 64

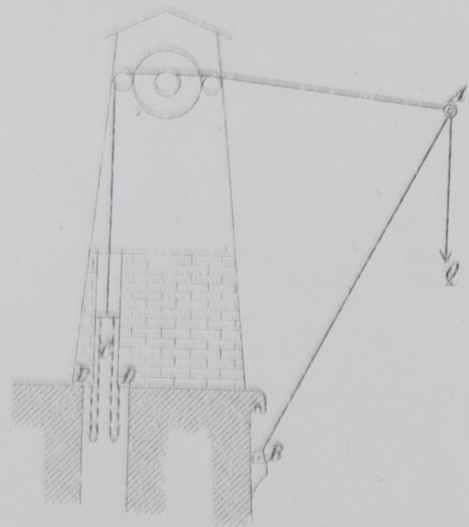

Черт. 66

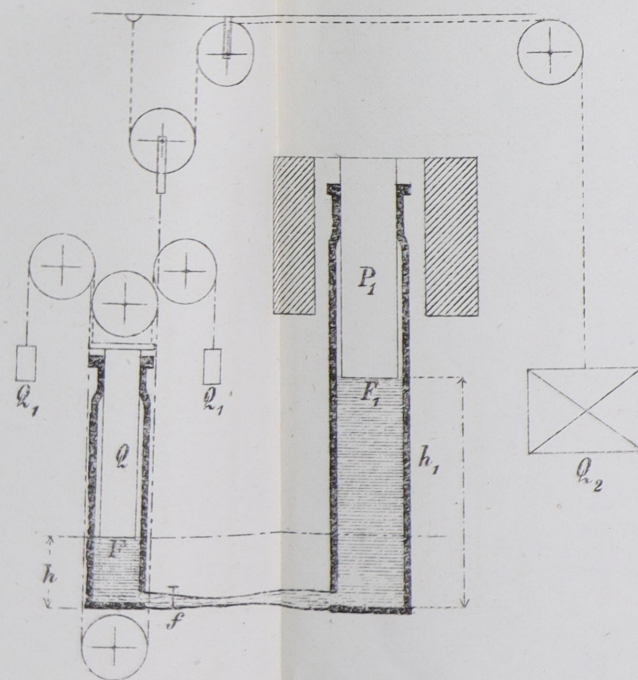

1:20

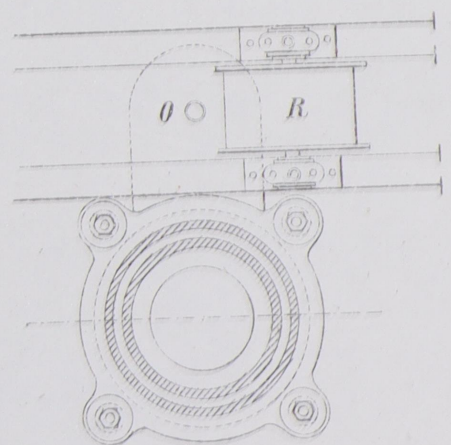

Черт. 67

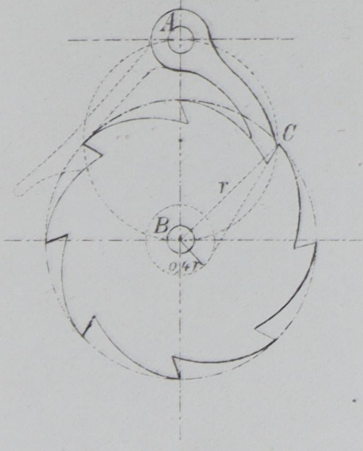

Черт. 68

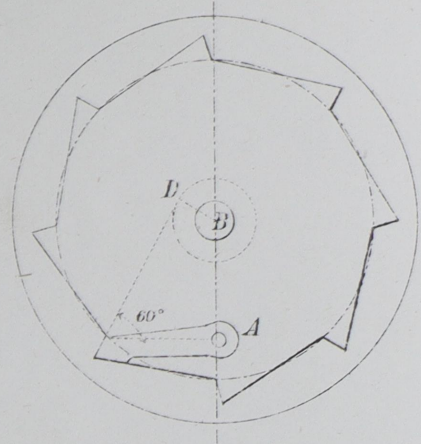

Черт. 69

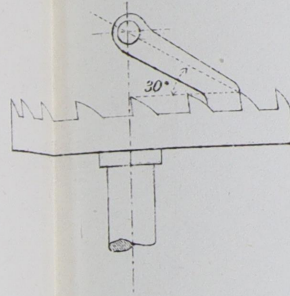

Черт. 70

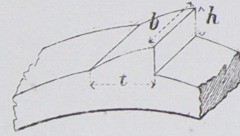

Черт. 71

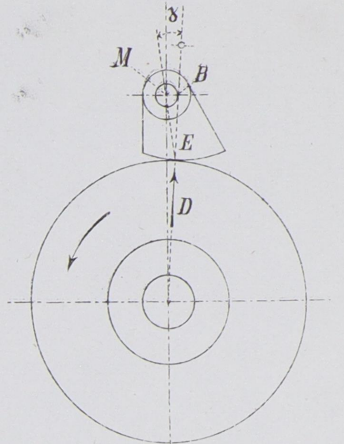

Черт. 72

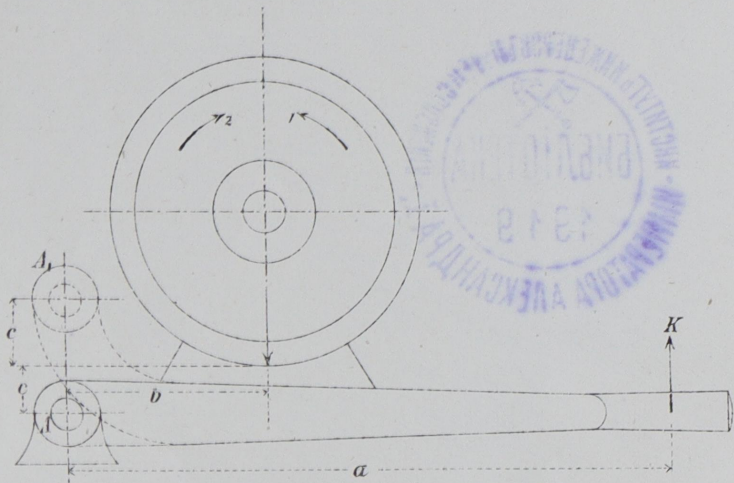

Черт. 73

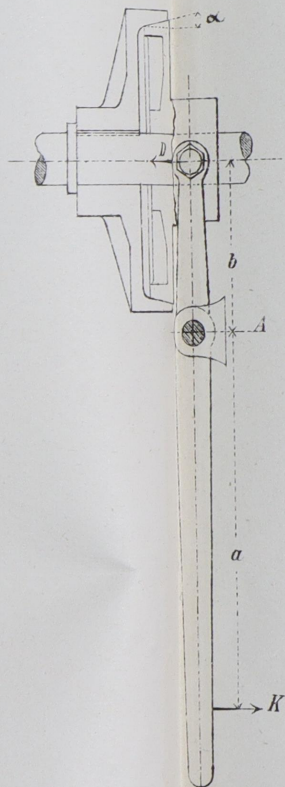

Черт. 74

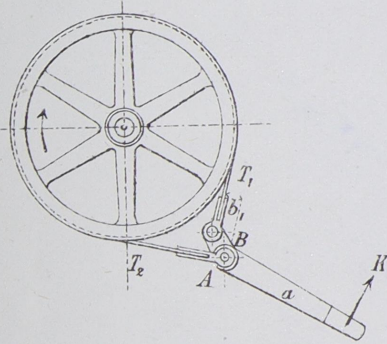

Черт. 75

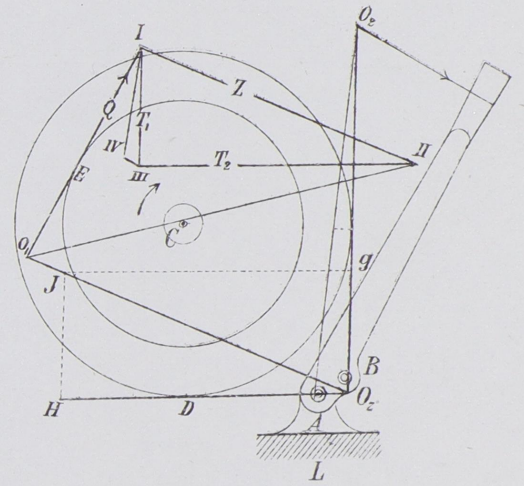

Черт. 77

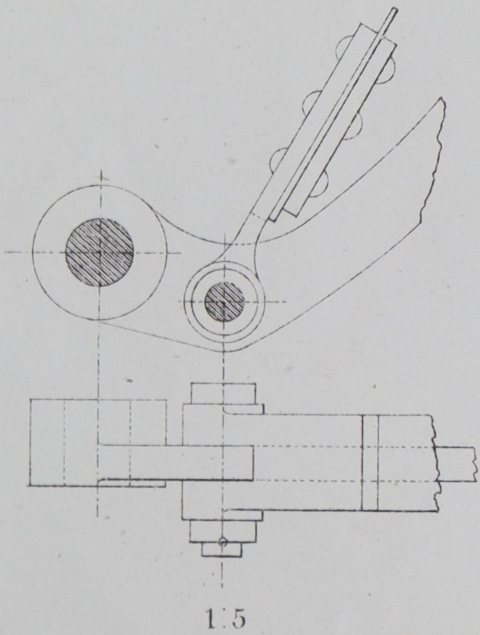

Черт. 76

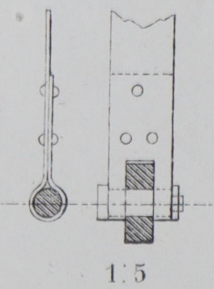

Черт. 78

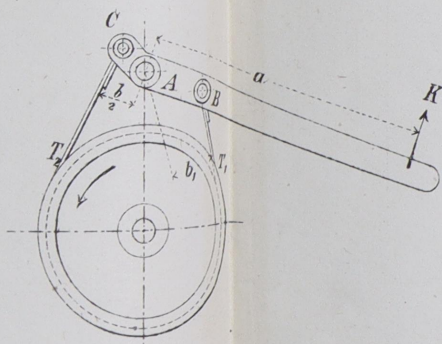

Черт. 79

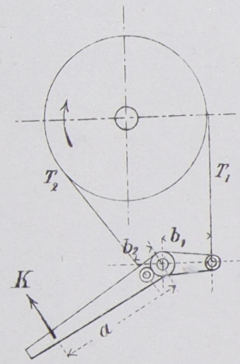

Черт. 80

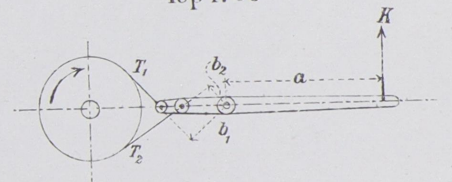

Черт. 81

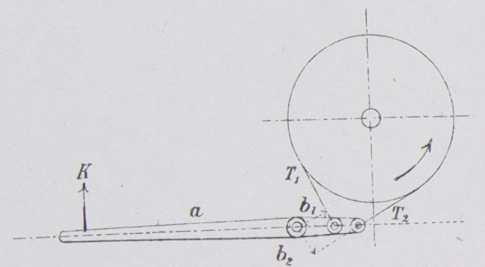

Чер. 82.

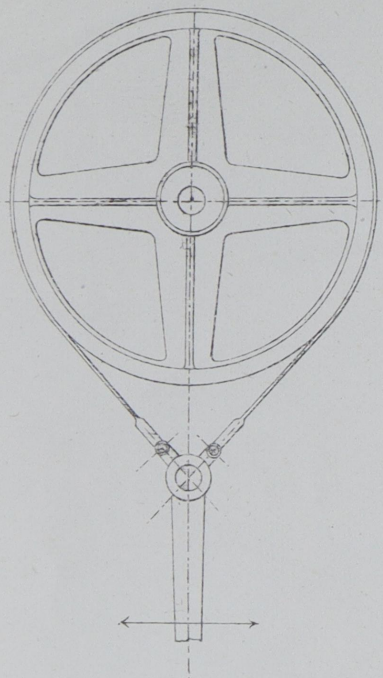

Чер. 83.

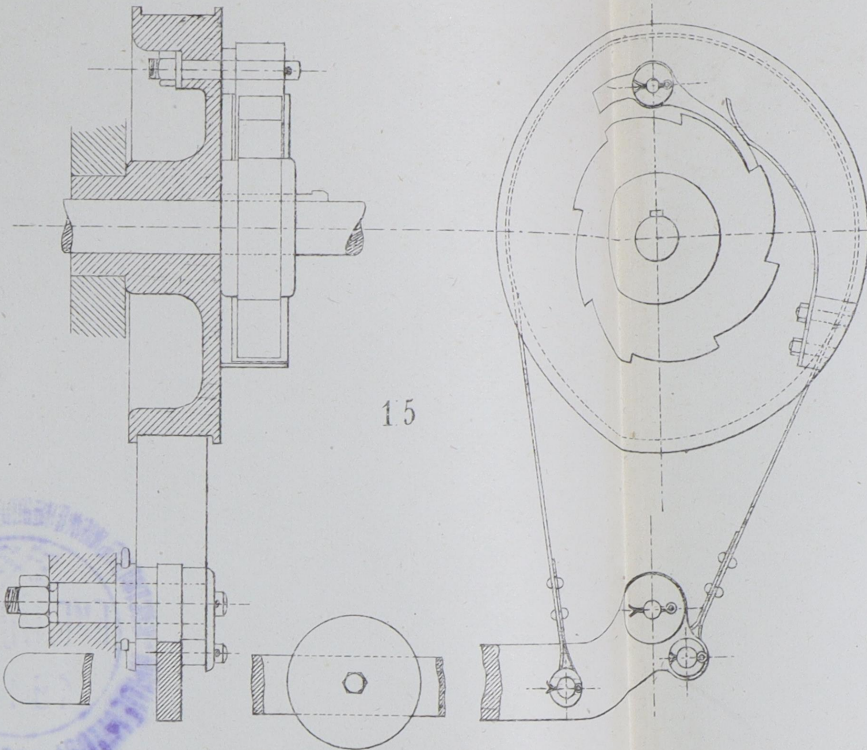

Чер. 94.

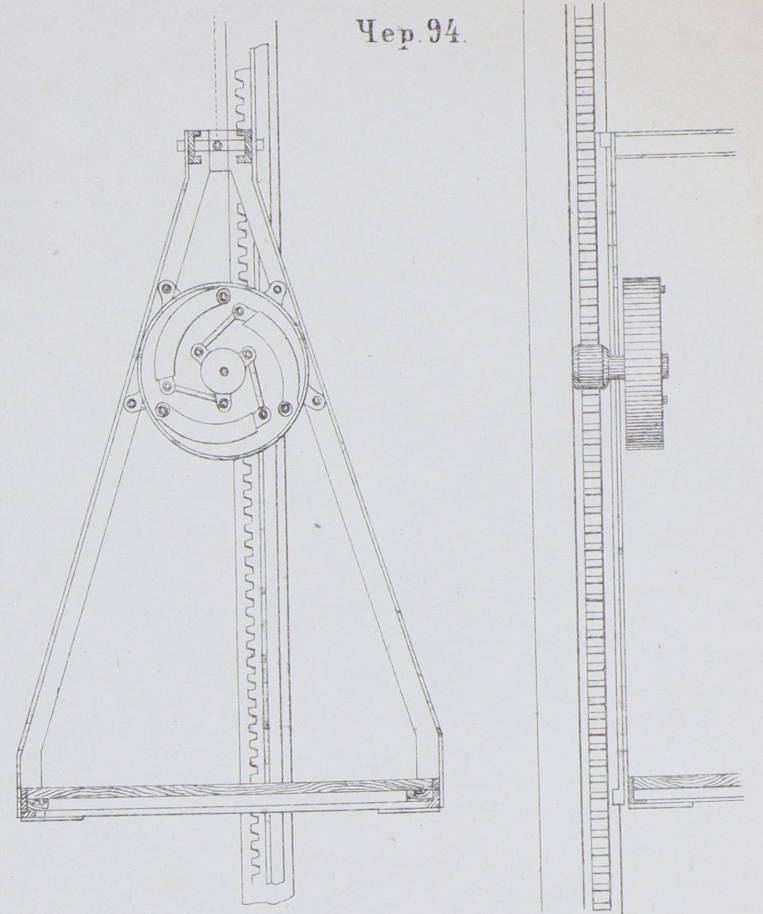

Чер. 93.

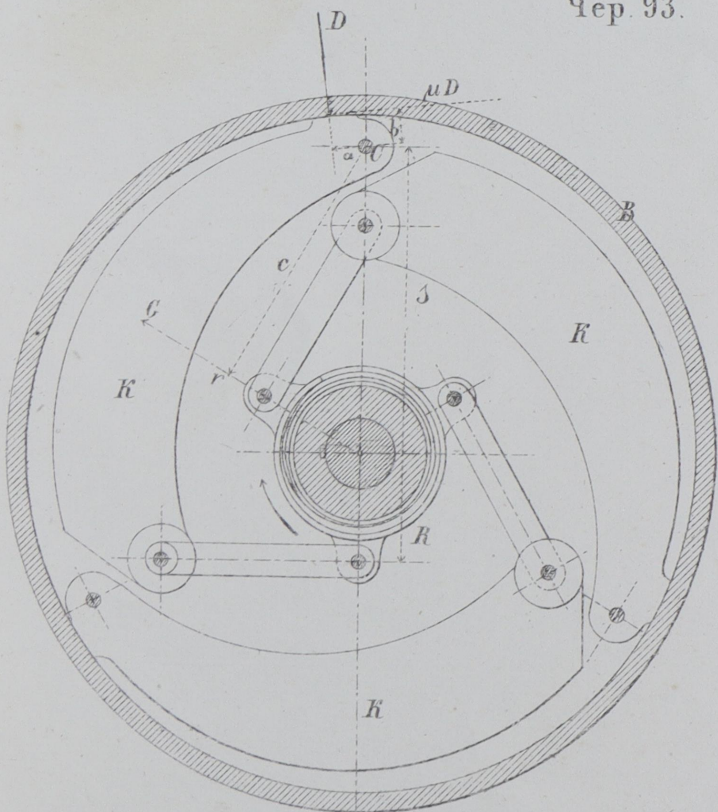

Чер. 86.

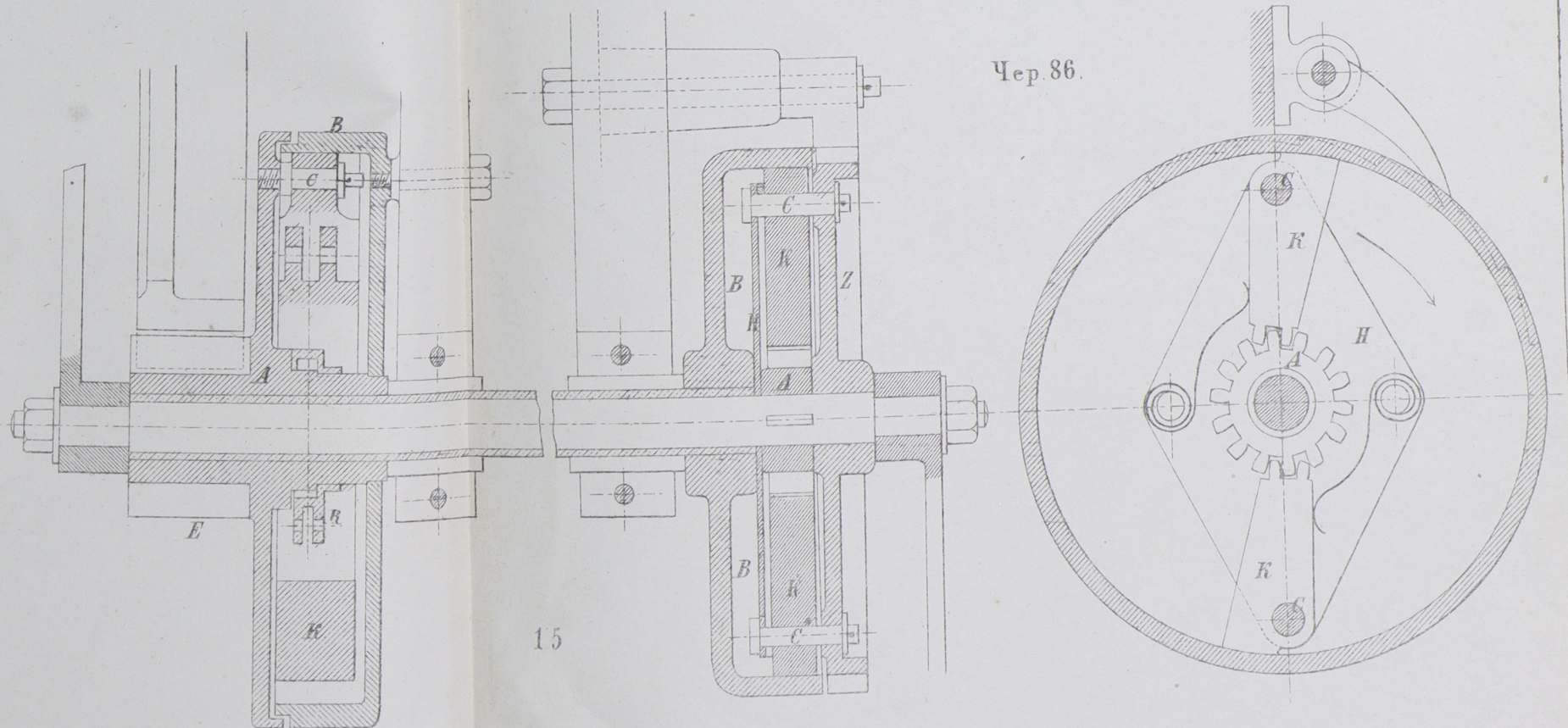

Чер.84.

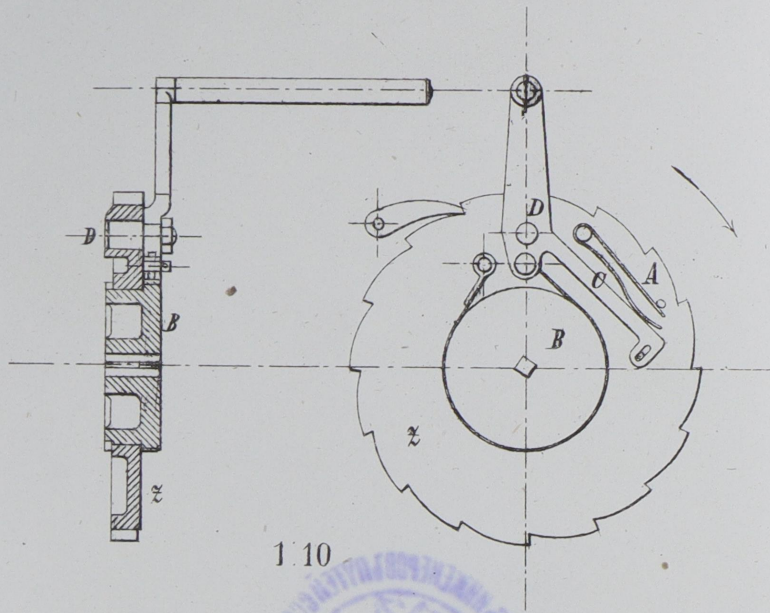

1:10

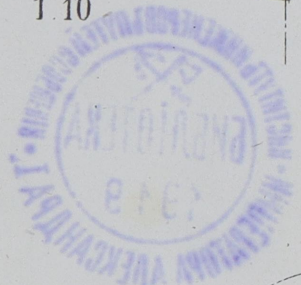

Чер.91

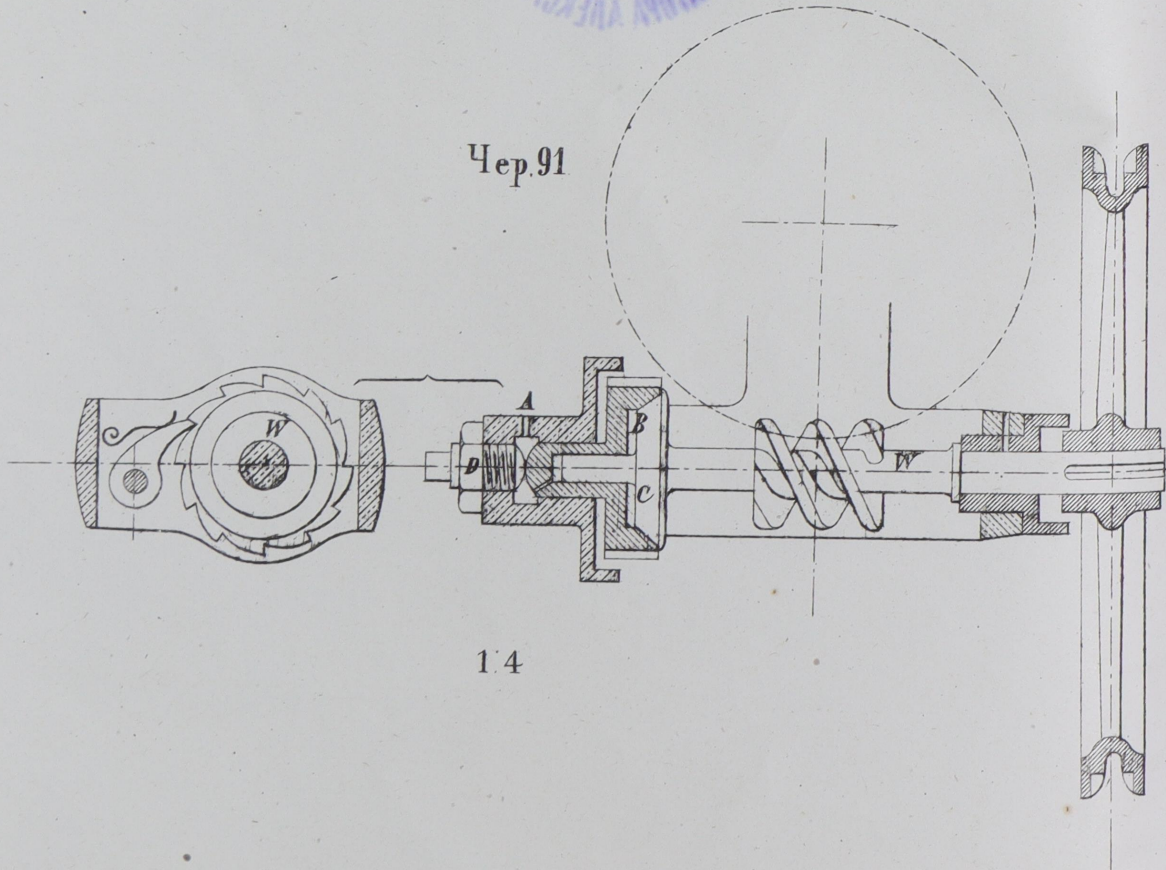

1:4

Чер.85

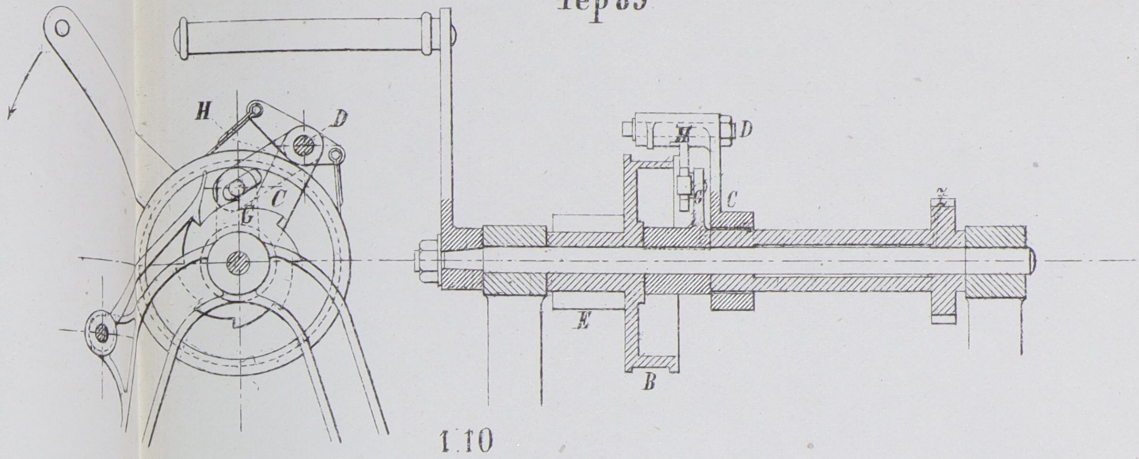

1:10

Чер.87

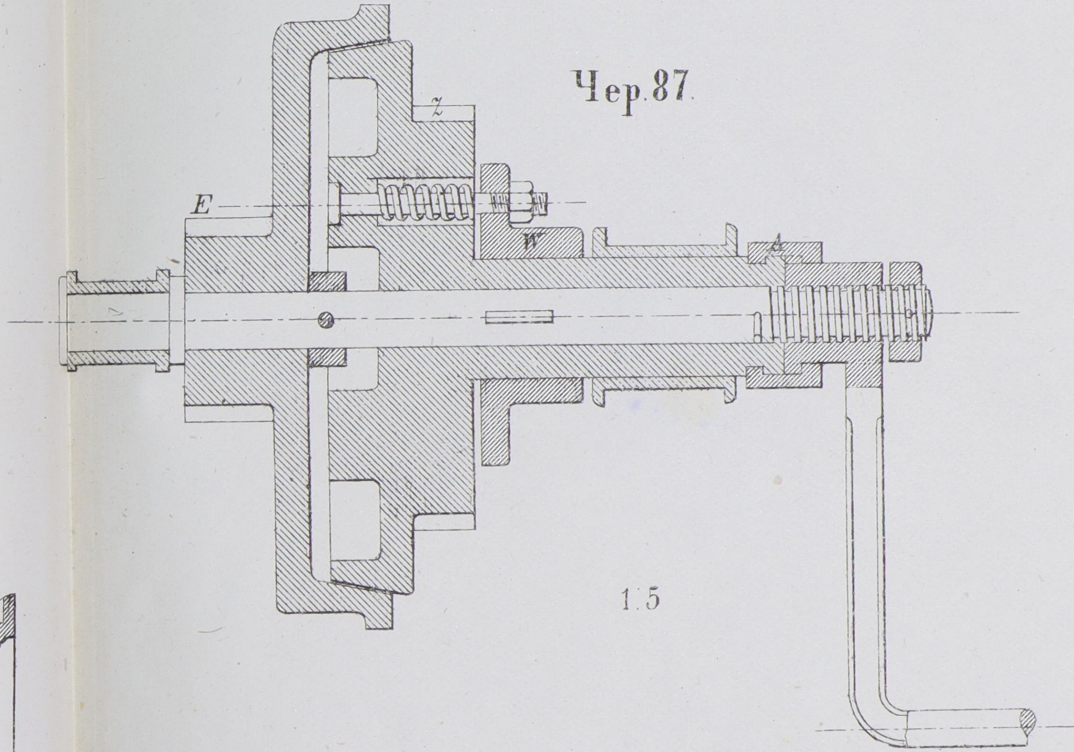

1:5

Чер.88

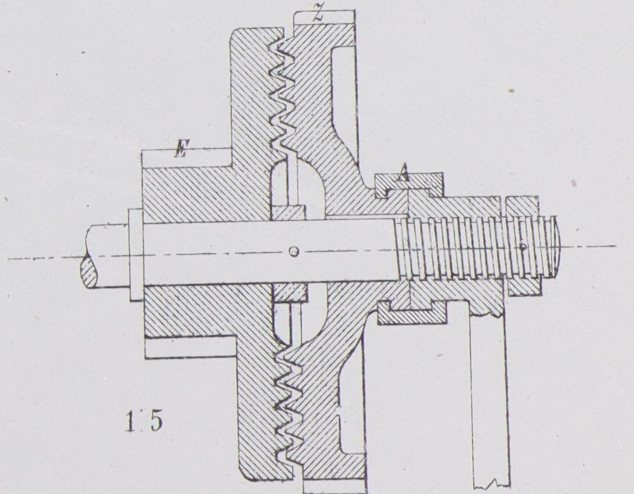

1:5

Чер.91^{б.с.}

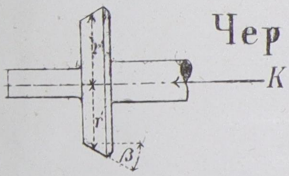

Чер. 89

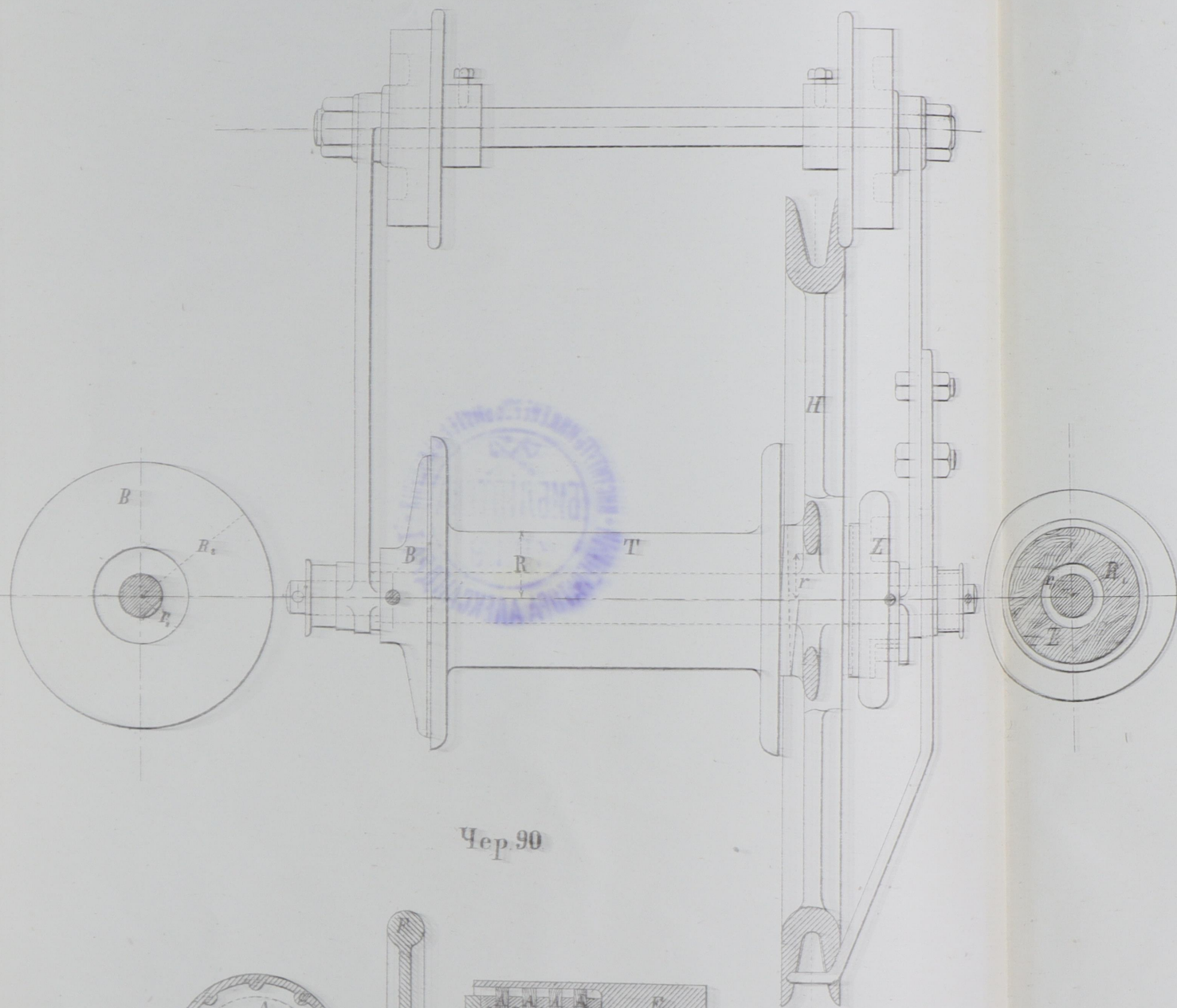

Чер. 90

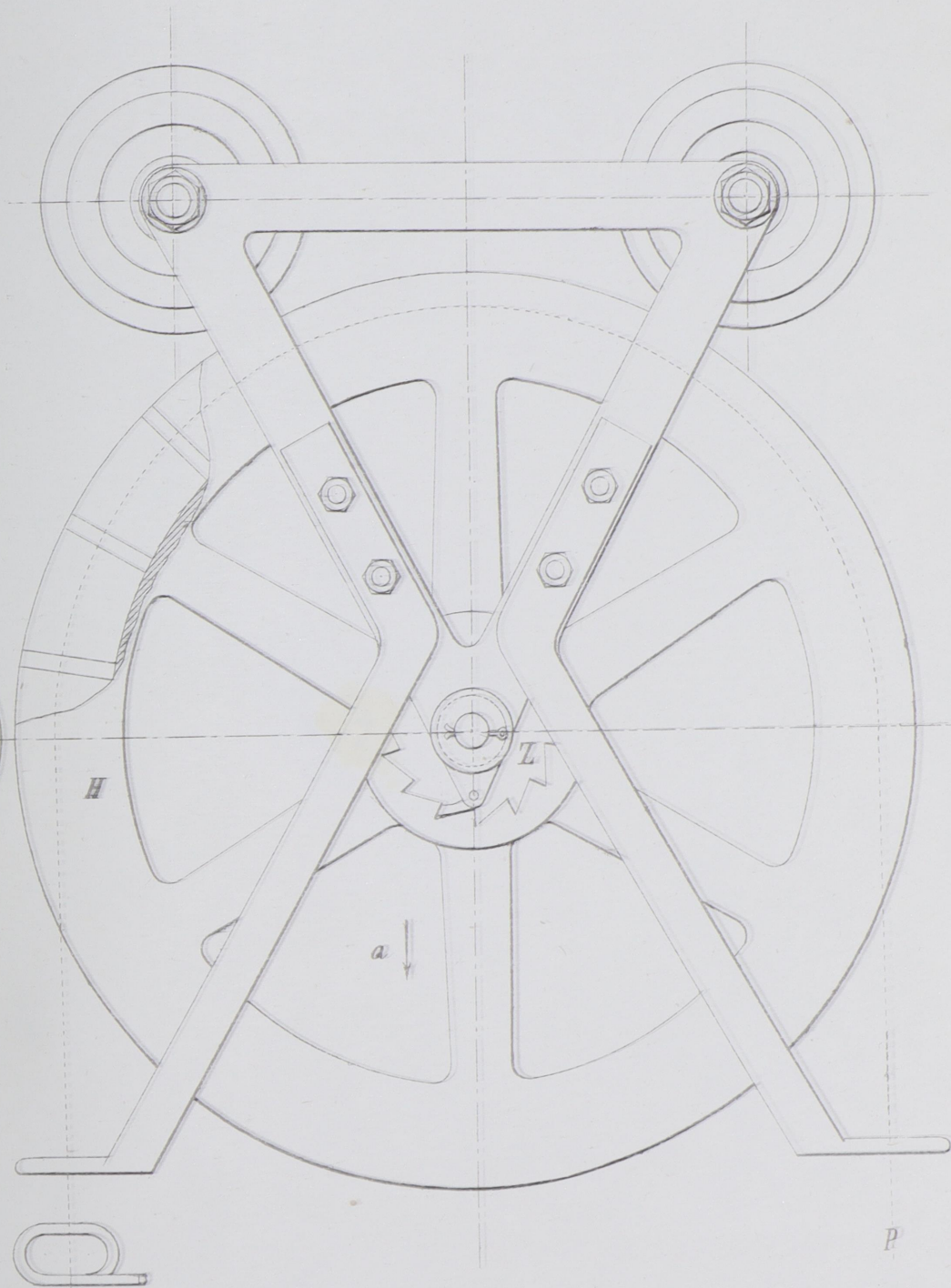
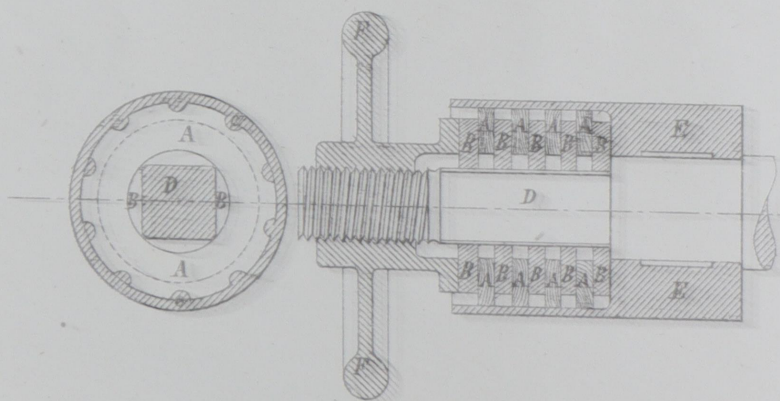

Чер. 95

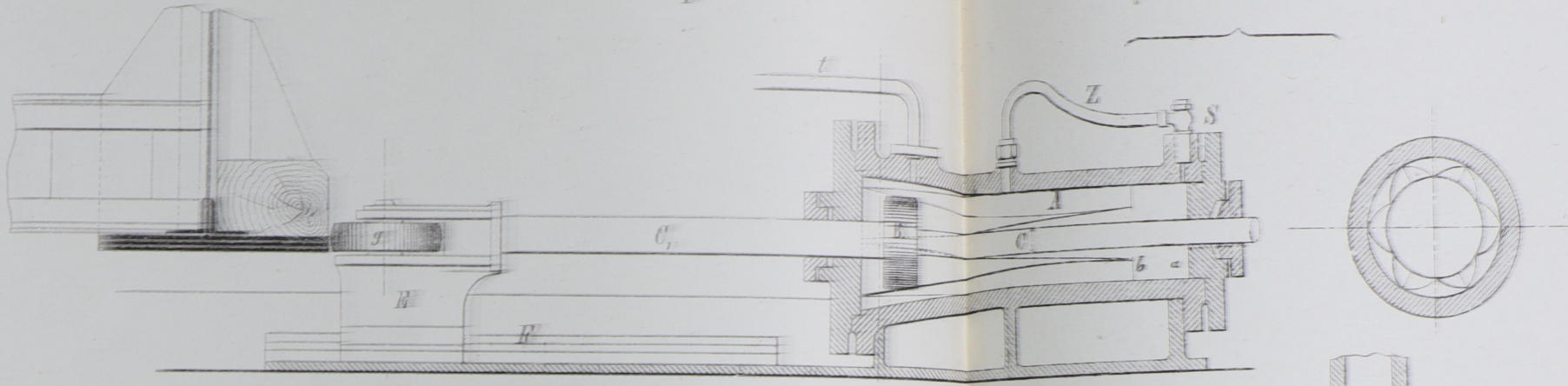

Чер. 96

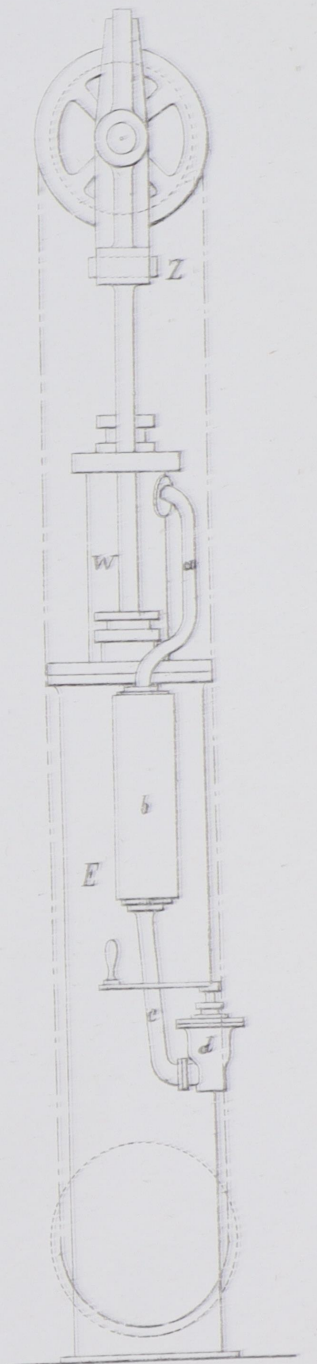

Чер. 98

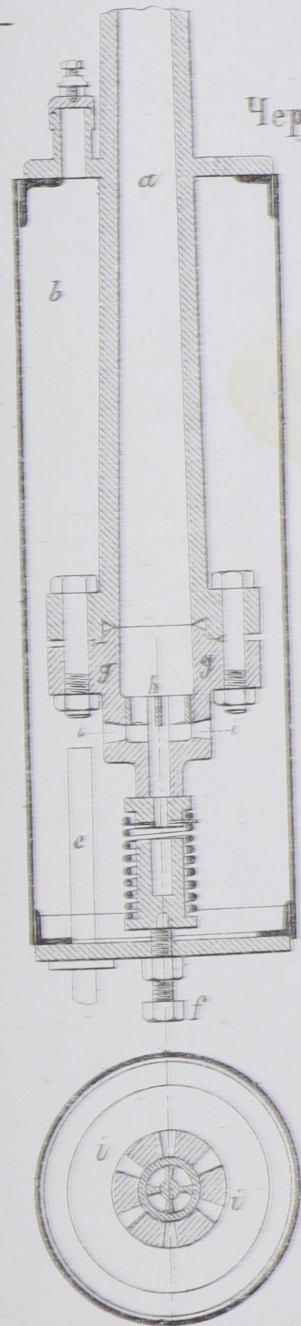

Чер. 97

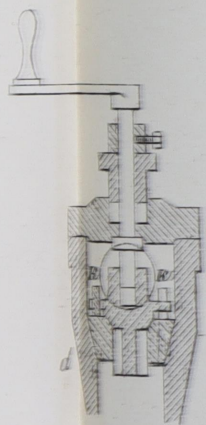

Чер. 92

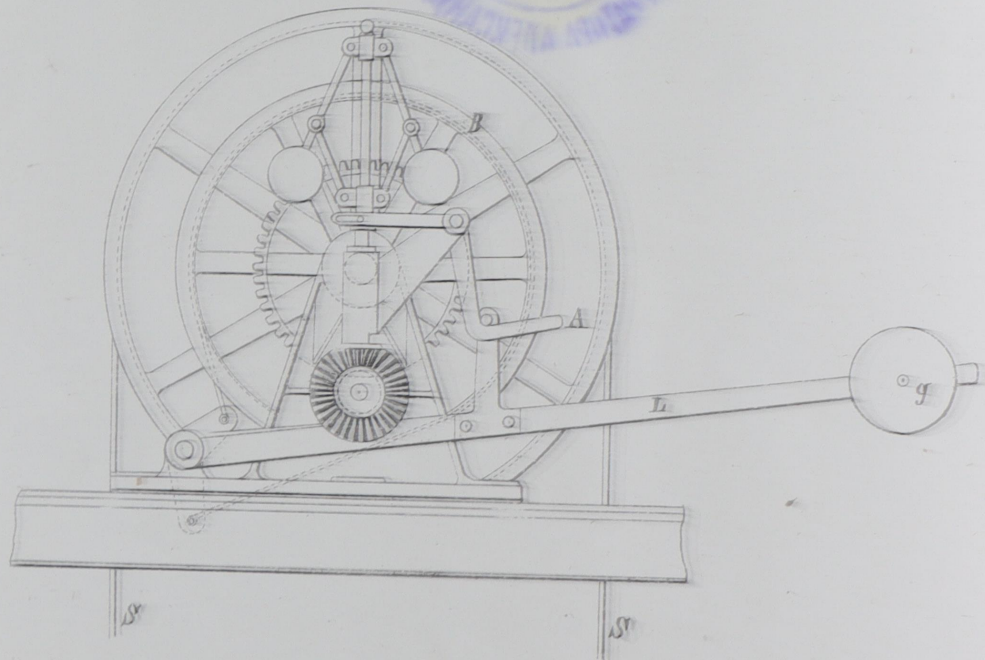

Чер. 99.

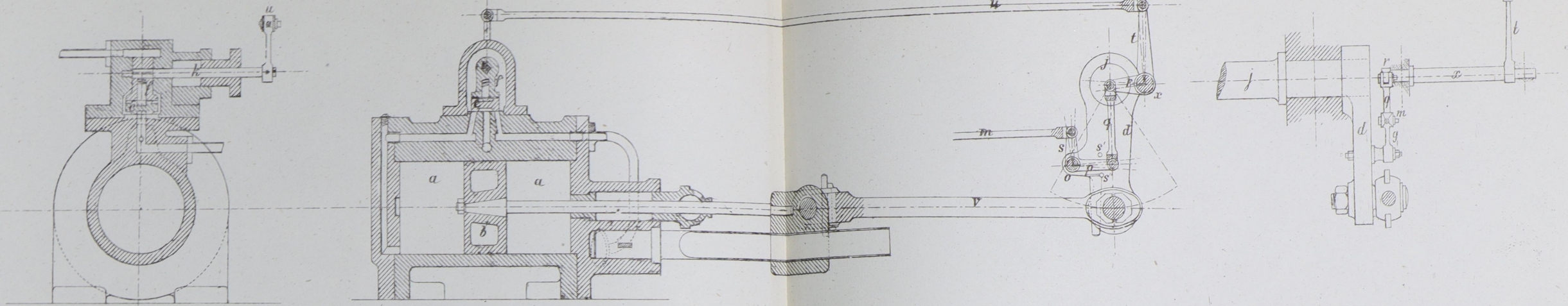

Чер. 99. ^{виз}

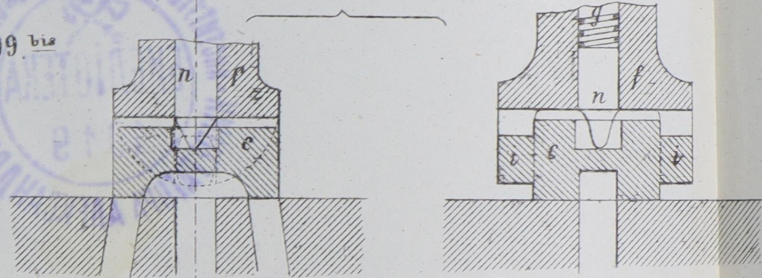

Чер. 100.

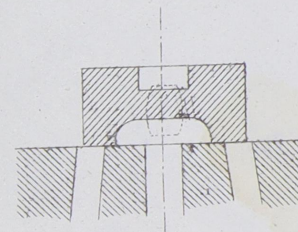

Чер. 101.

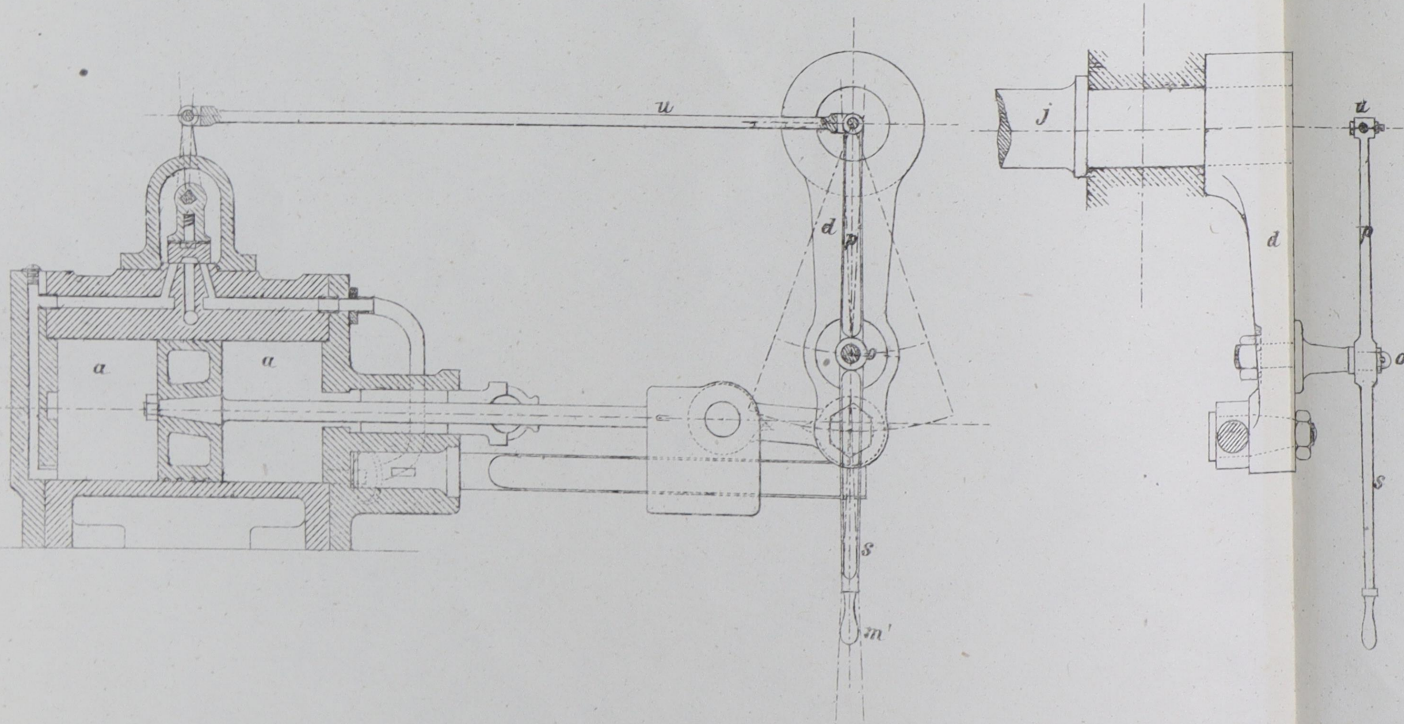

Чер. 102.

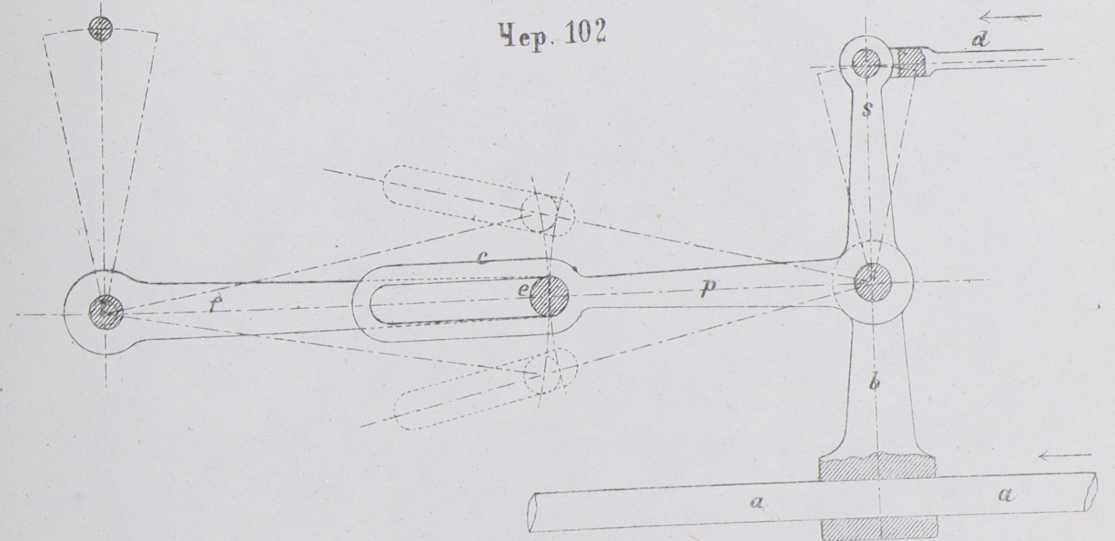

Чер. 103

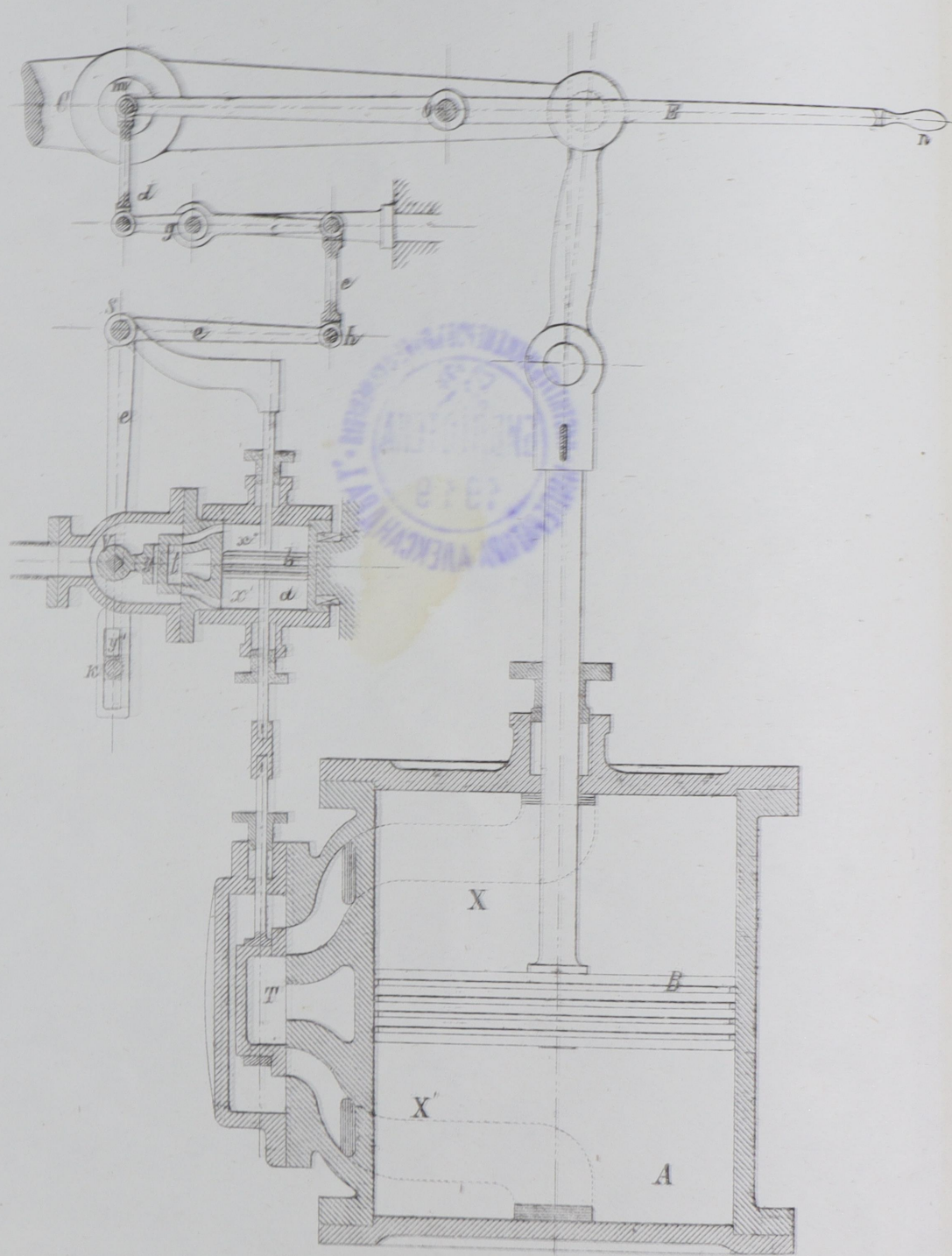

Чер 104

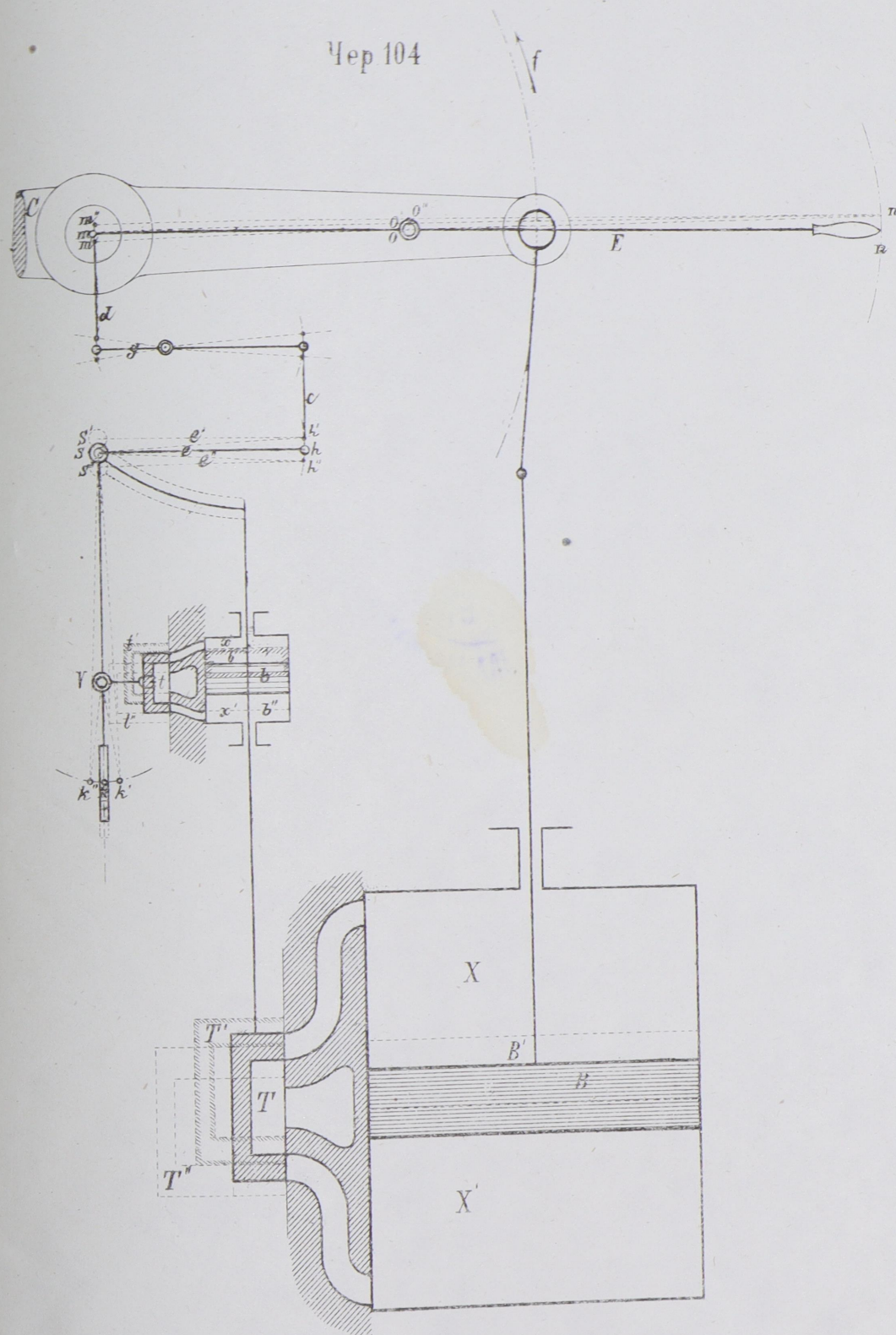

БИБЛИОТЕКА
 Белорусского
 института инженеров
 железнодорожного
 транспорта

Чер 105

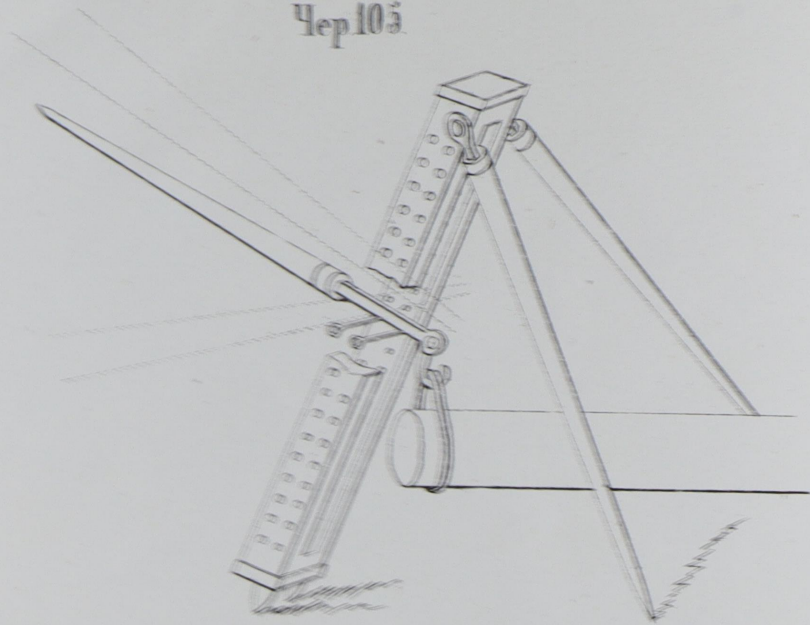

Чер 106

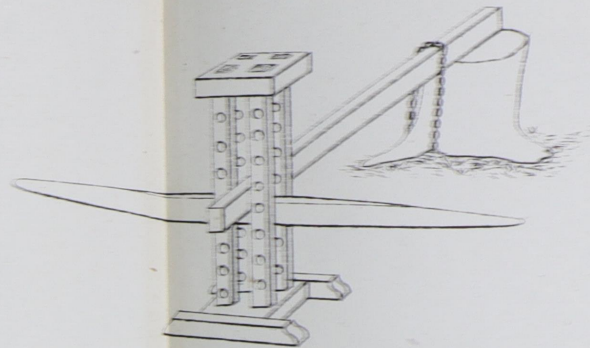

Чер 107

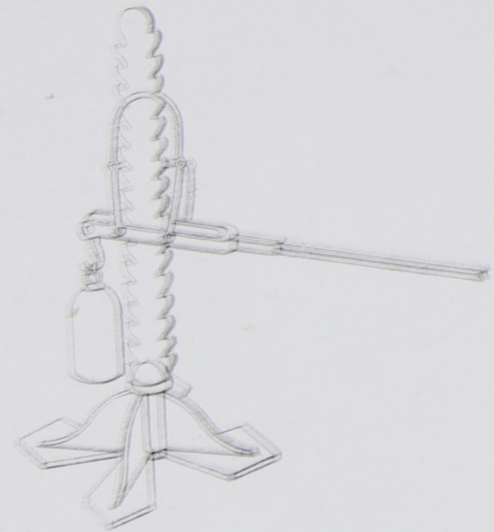

Чер 108

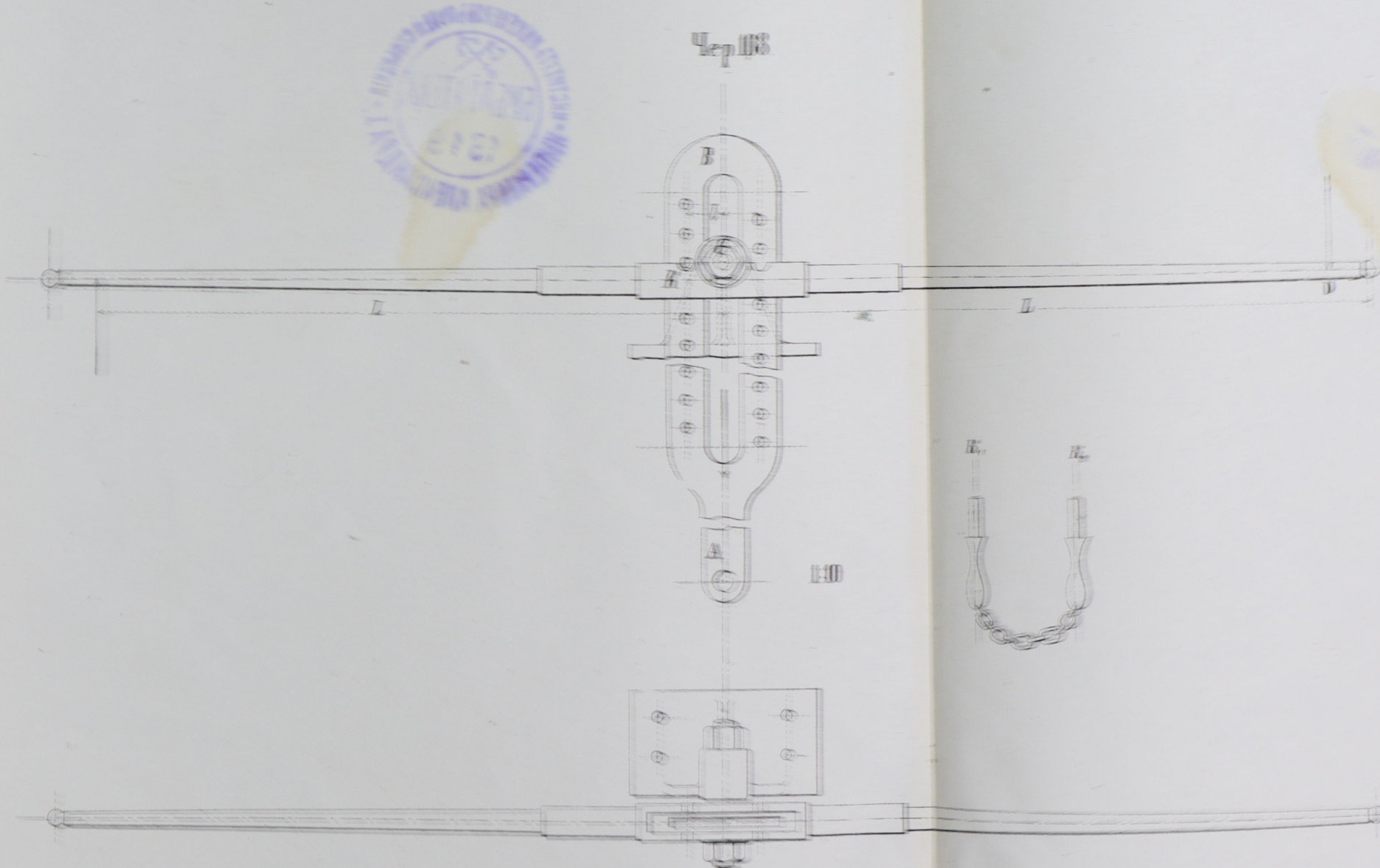

Чер 109

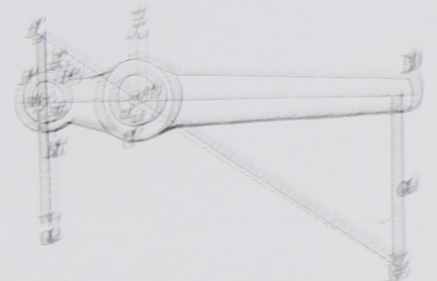

Чер 110

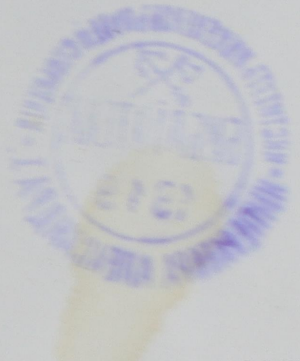
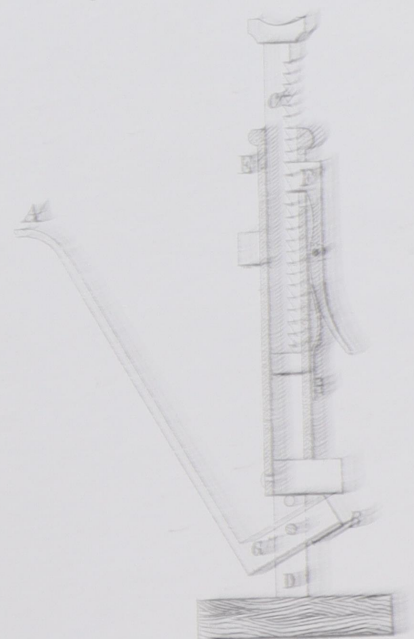

Чер 111

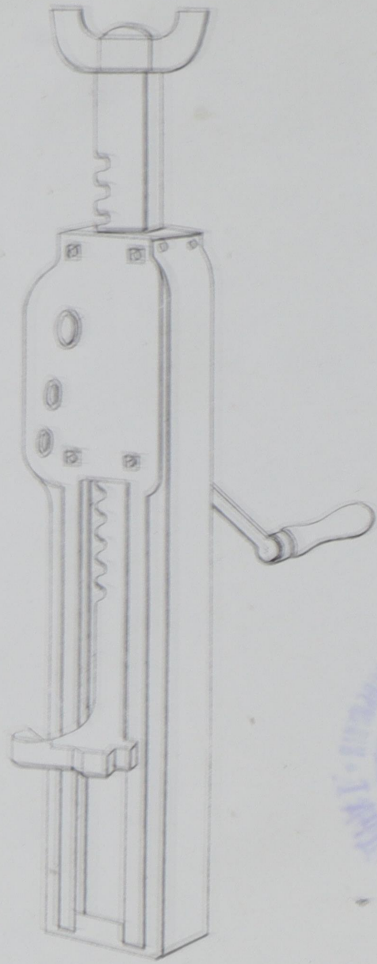

Чер 112

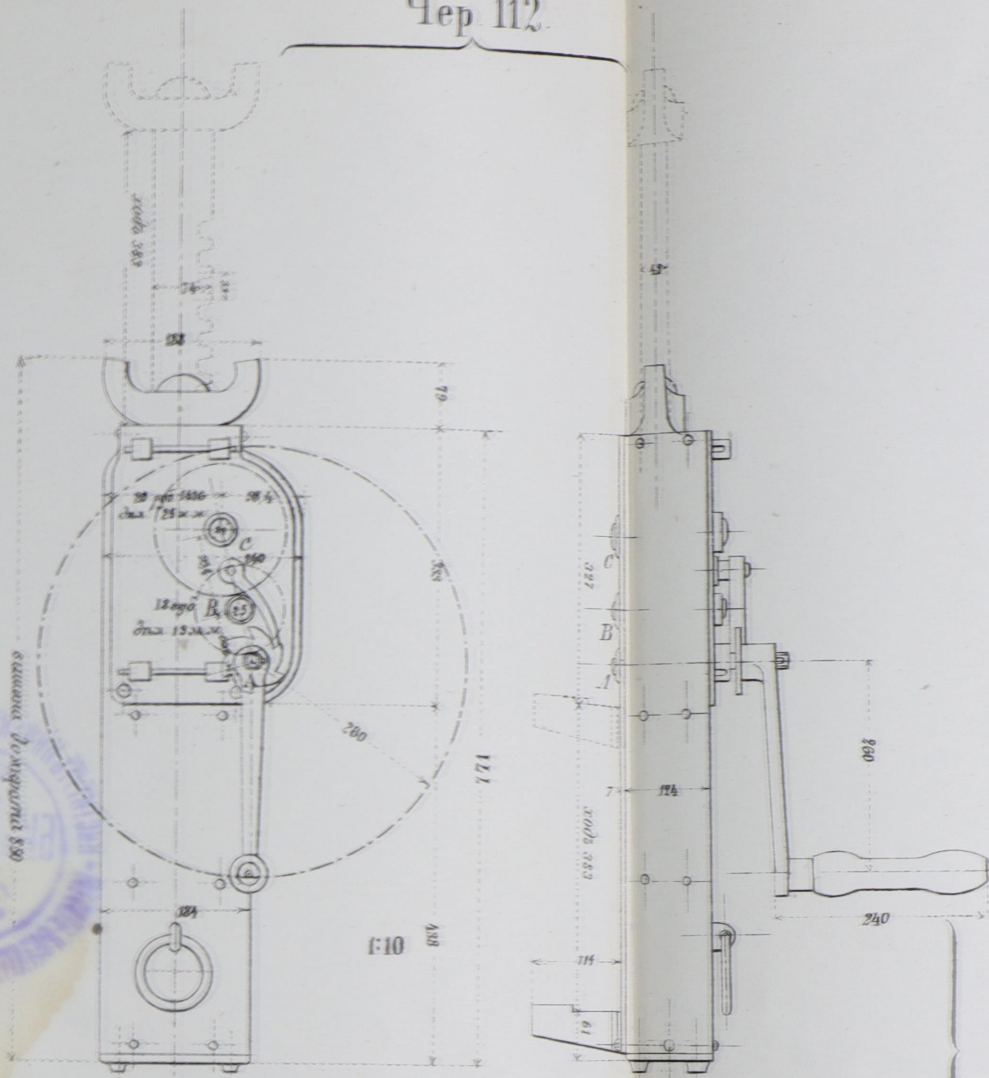

Чер 115

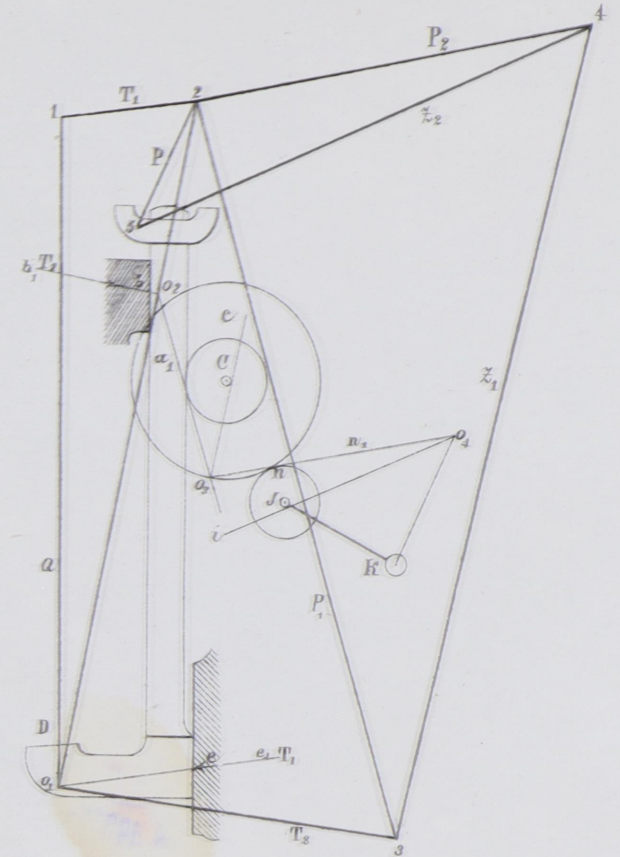

Чер 113

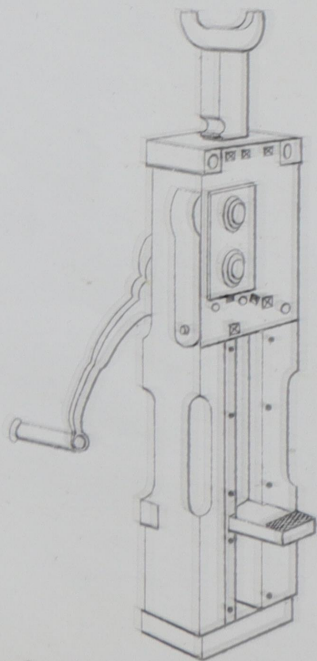

Чер 114

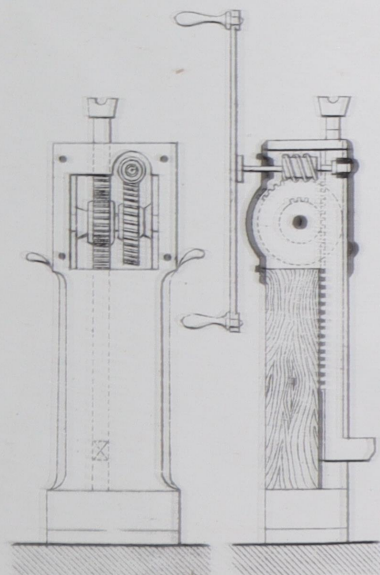

Чер 116

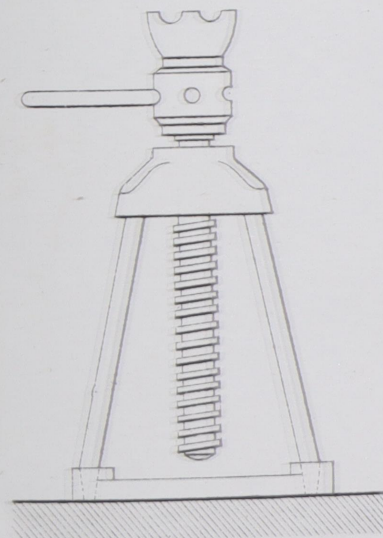

Чер 117

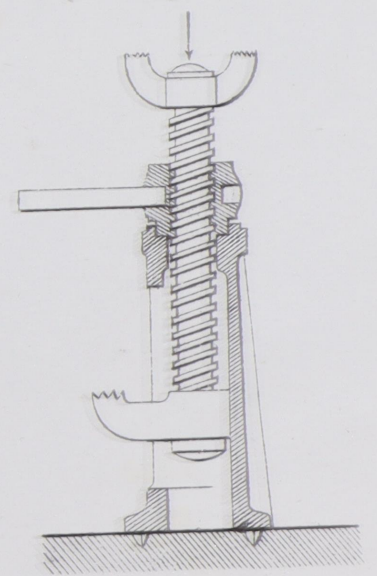

Чер 118

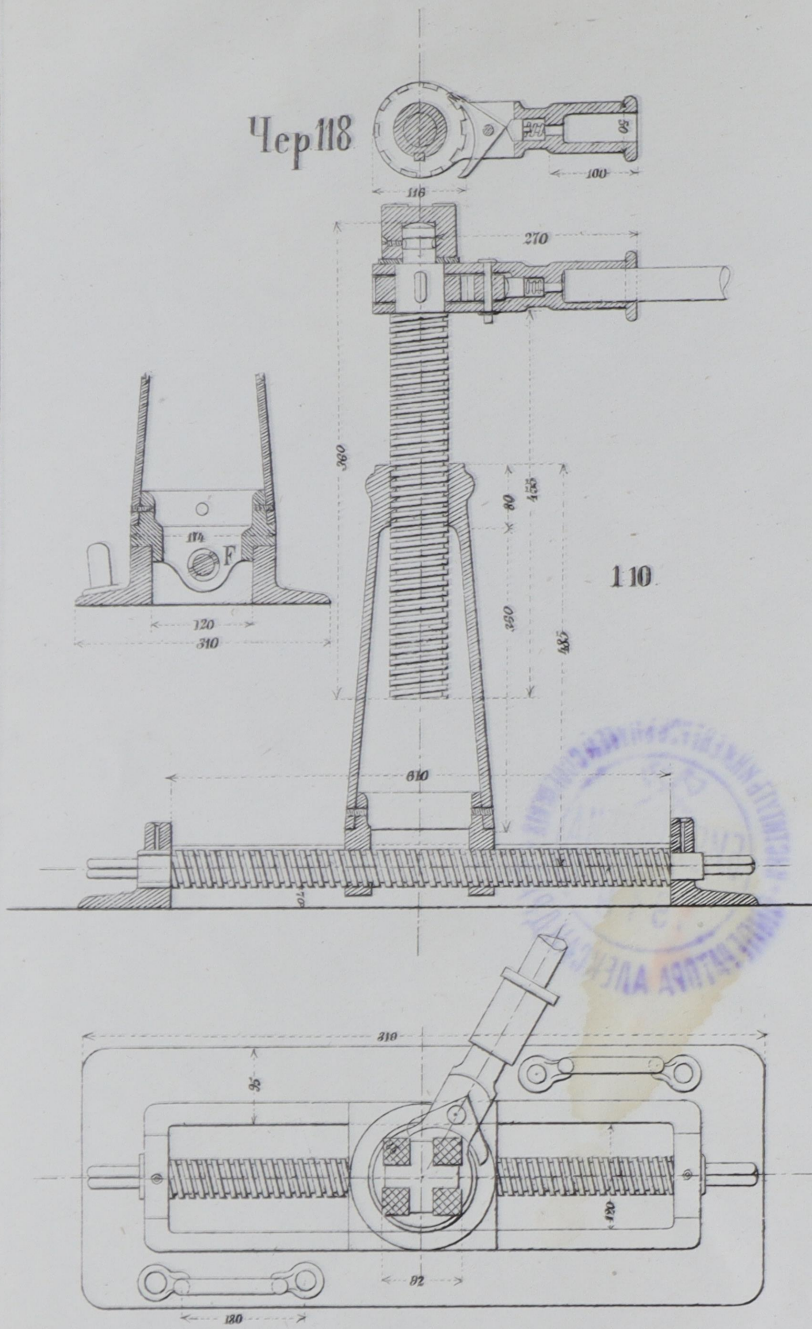

110

Чер 120

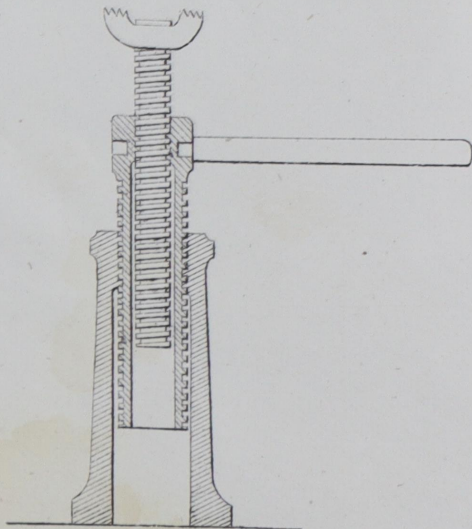

Чер 119^{тер.}

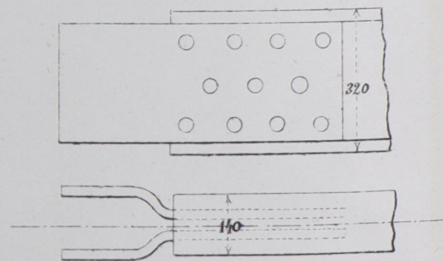

1:20

Чер 119

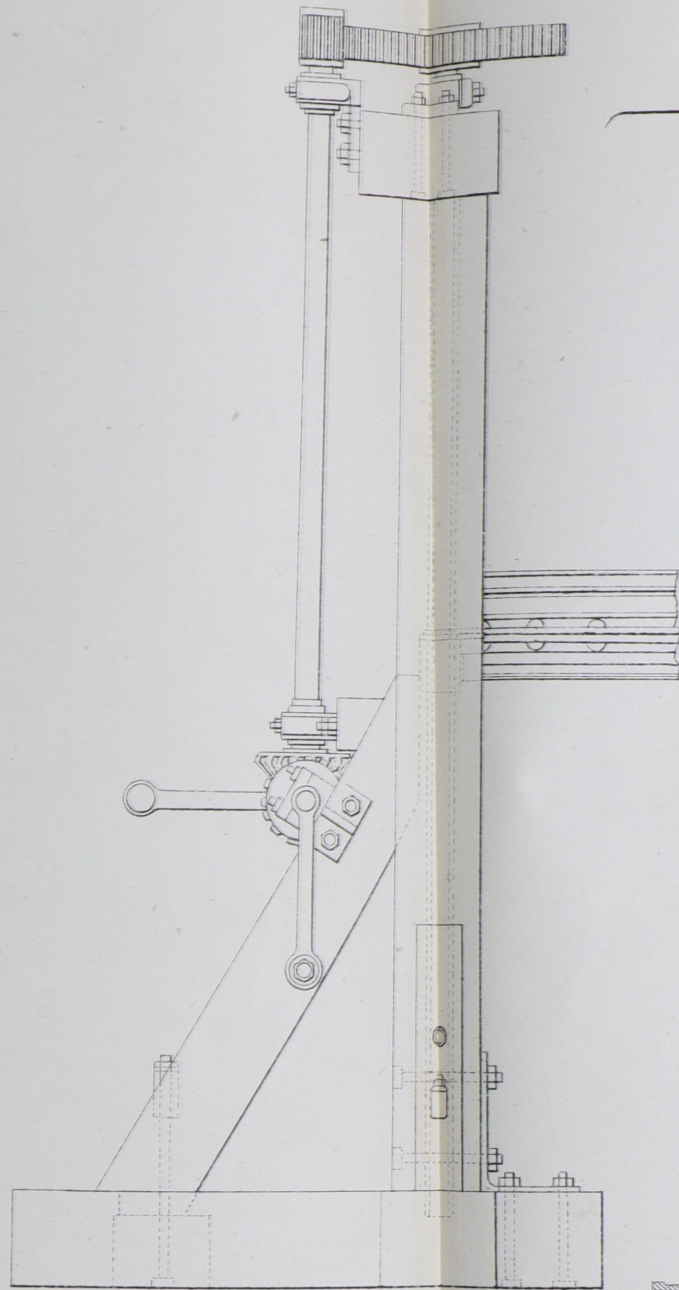

1:18

Чер 121

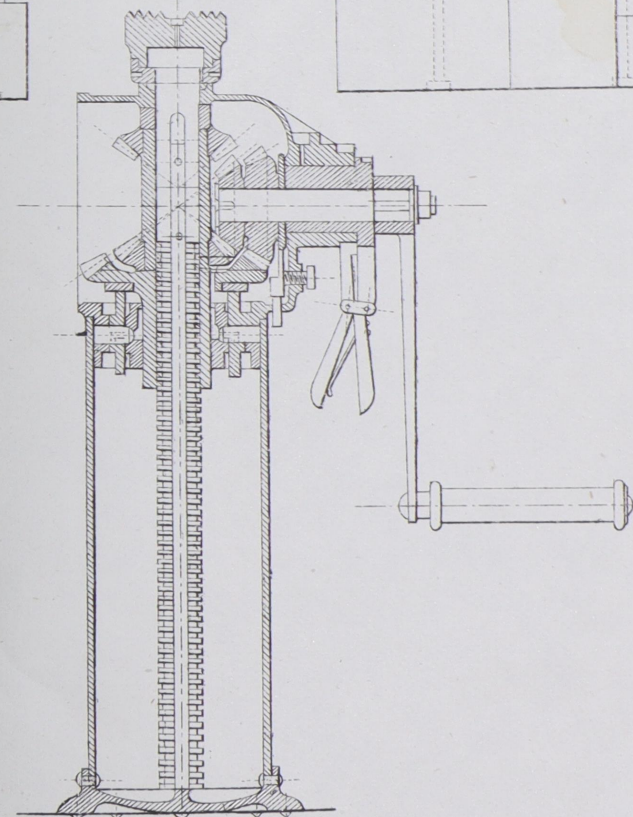

Чер 119^{bis.}

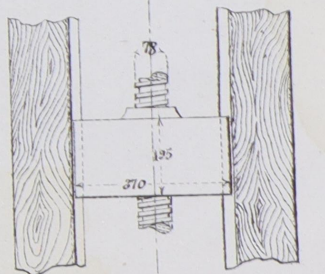

1:20

Чер 123

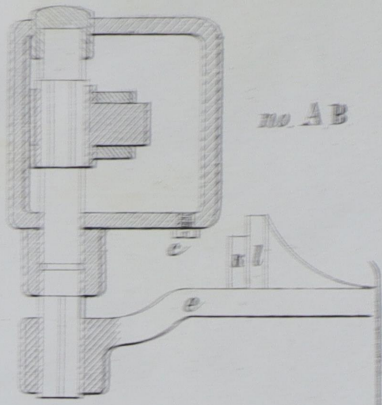

по АВ

Чер 124

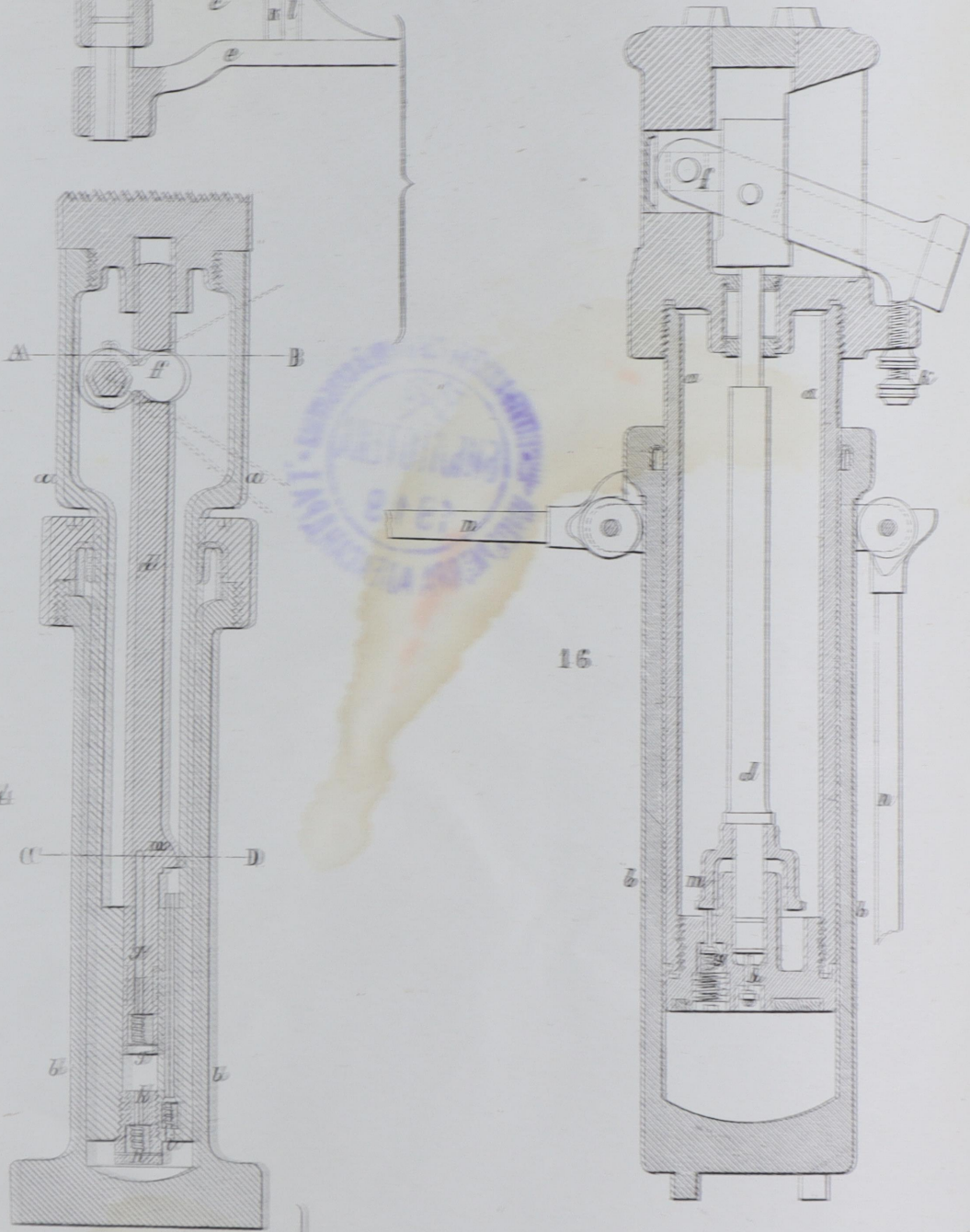

16

124

по CD

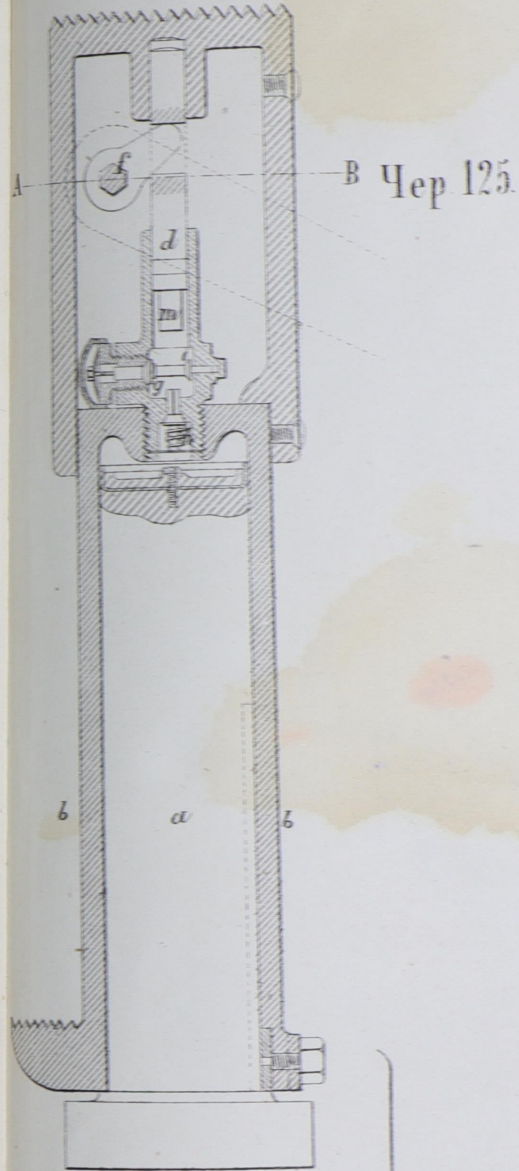

В Чер 125

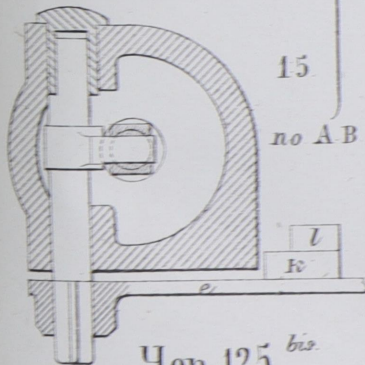

15 по АВ

Чер 125 bis

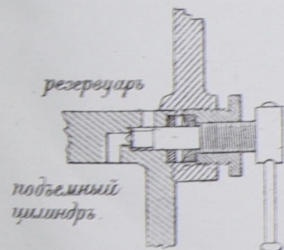

резервуар

подъемный цилиндр

Чер 122

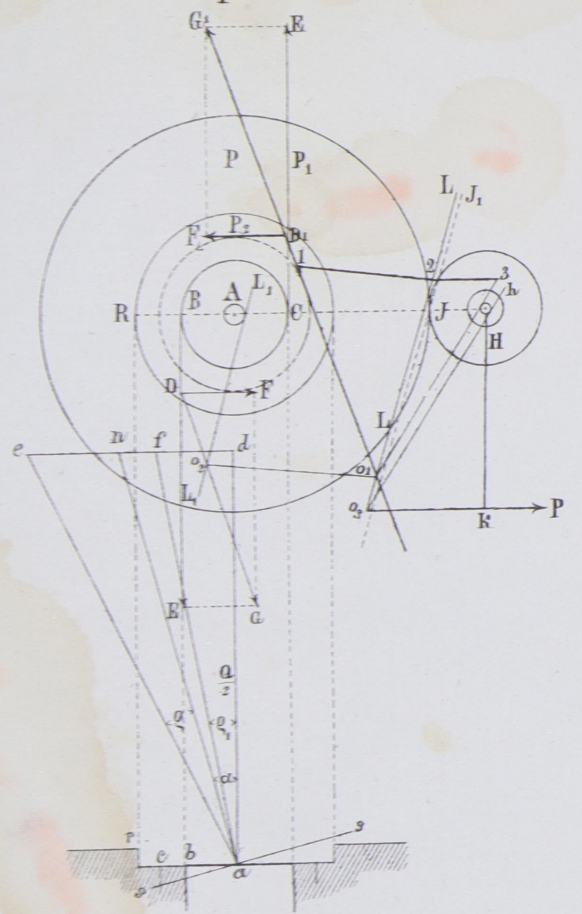

Чер 126

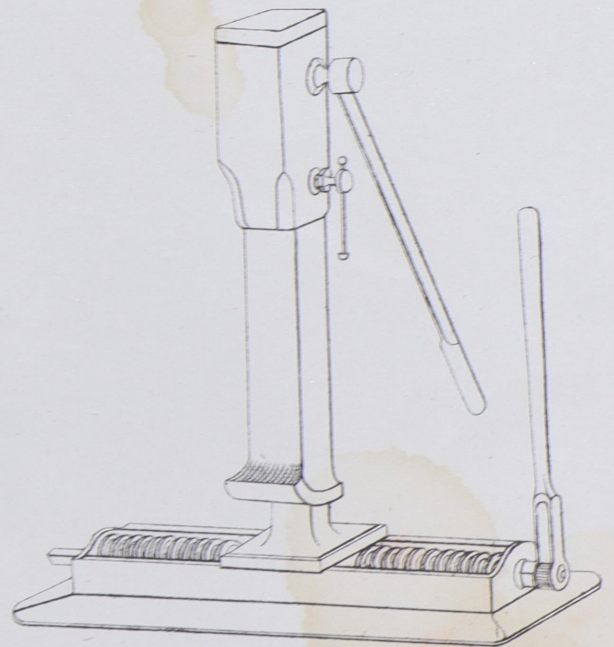

Чер.127.

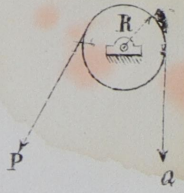

Чер.129.

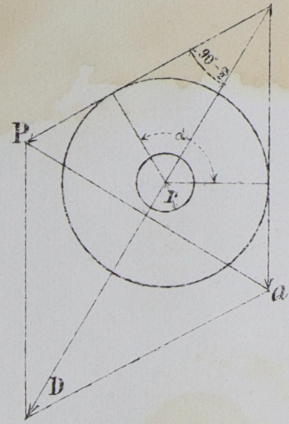

Чер.132.

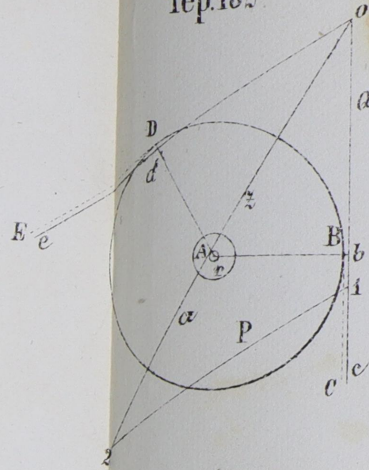

Чер.133.

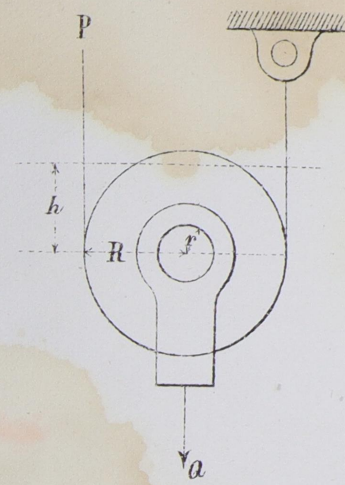

Чер.134.

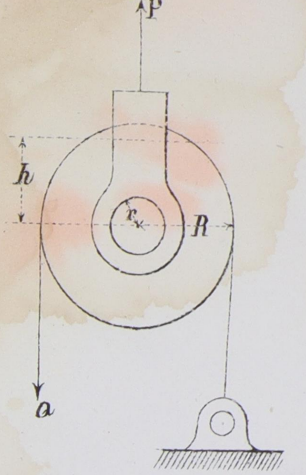

Чер.128.

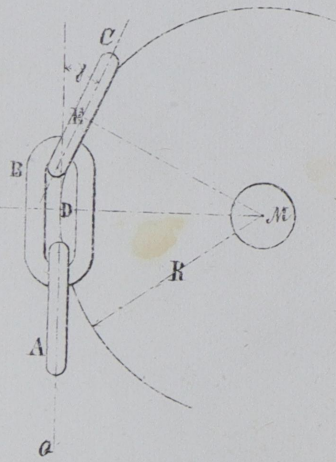

Чер.131.

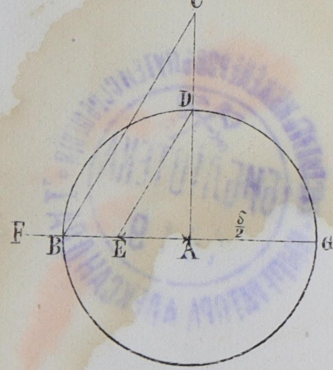

Чер.135.

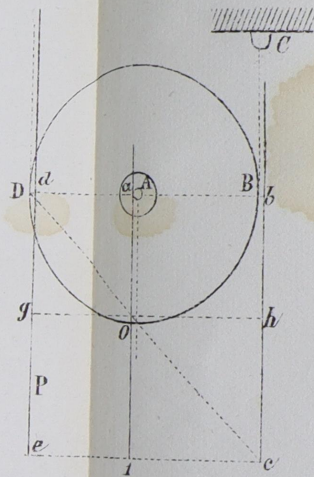

Чер.137.

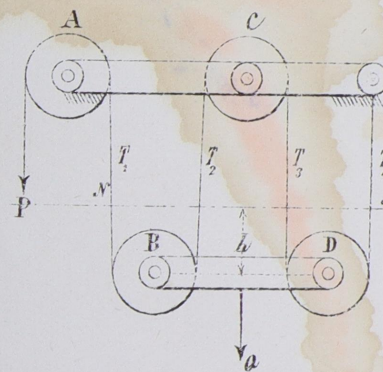

Чер.138.

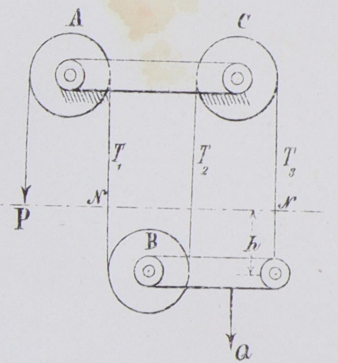

Чер.130.

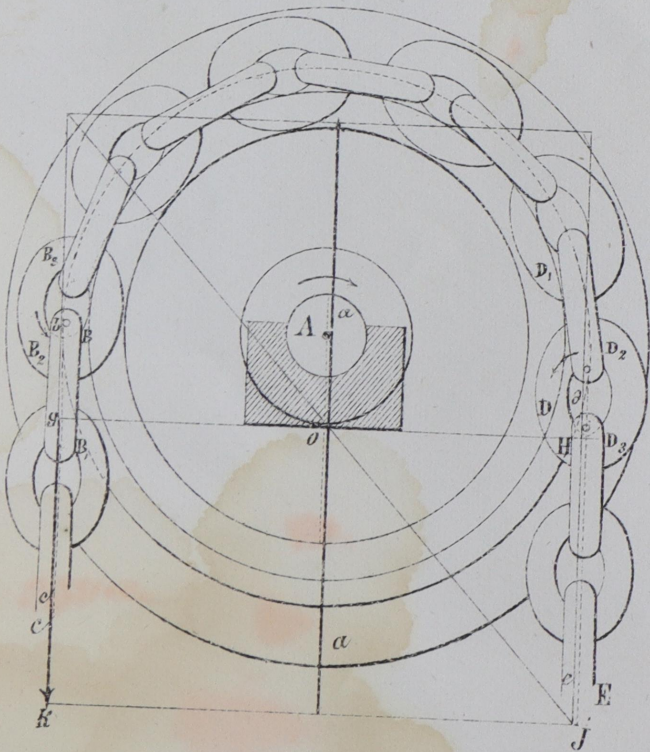

Чер.136.

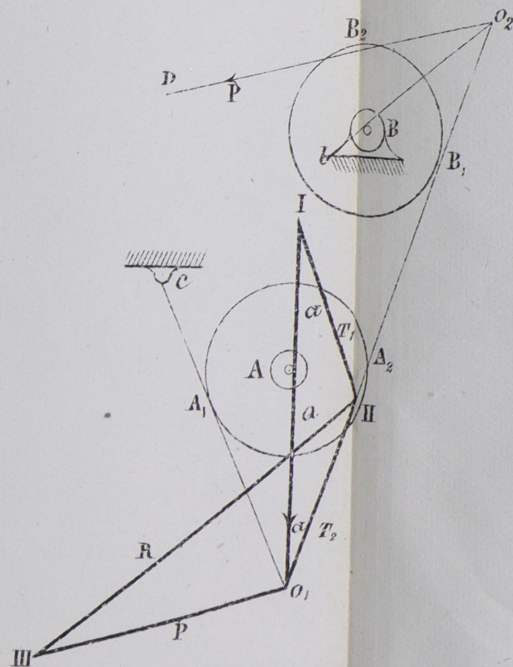

Чер.139.

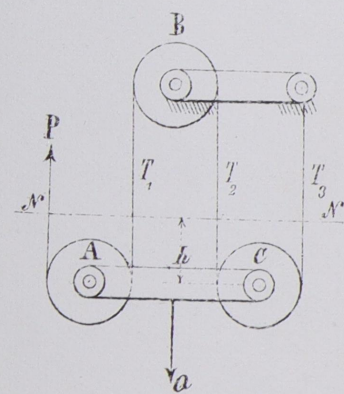

Чер.140.

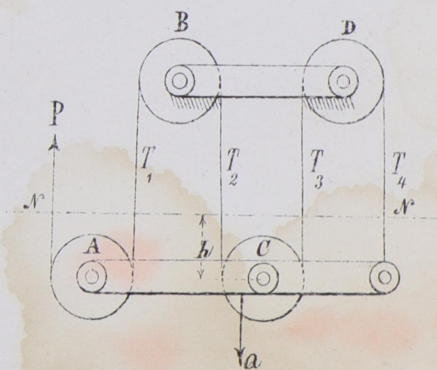

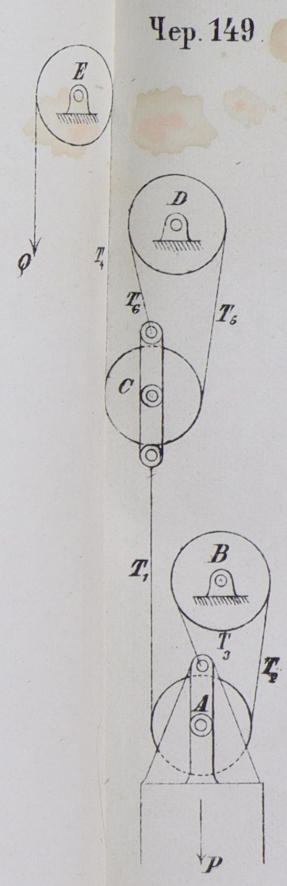
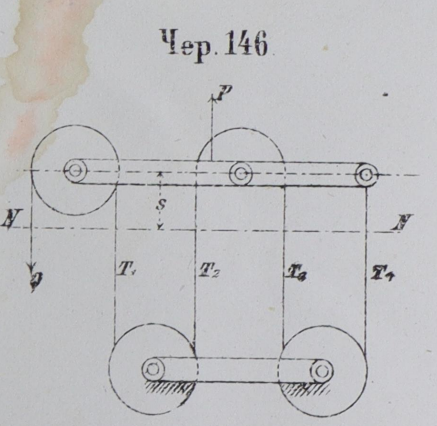
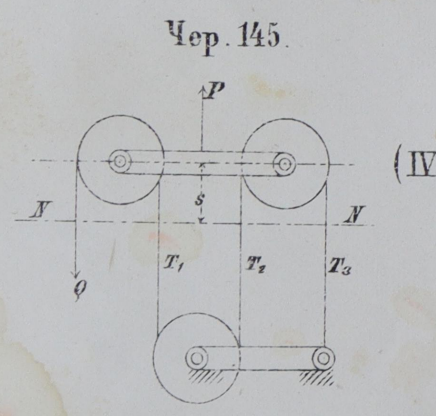
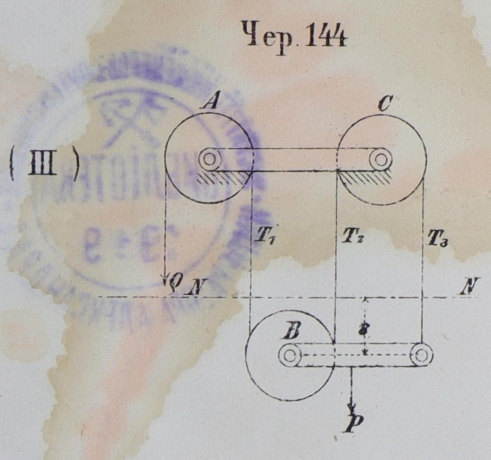
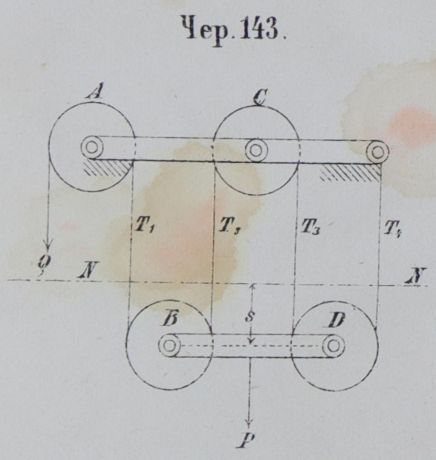
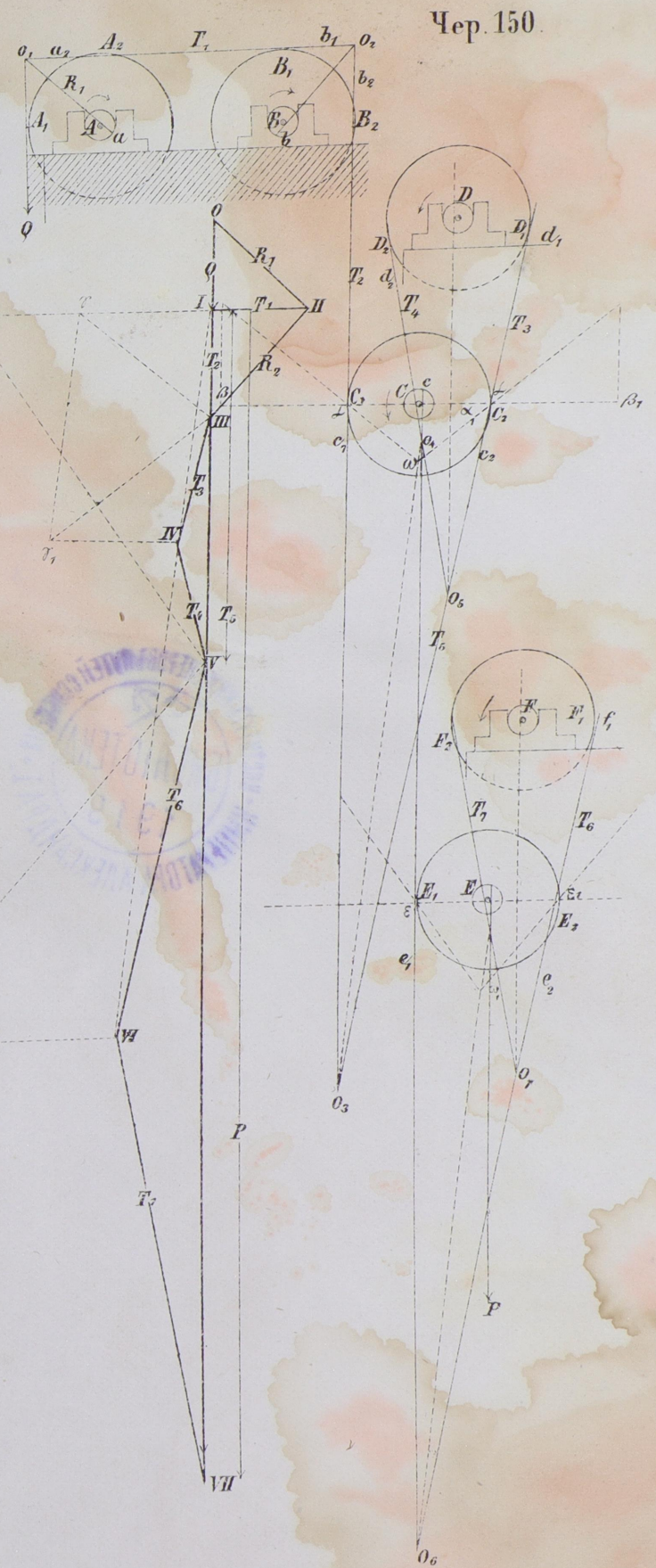
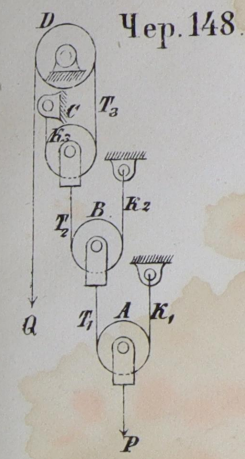
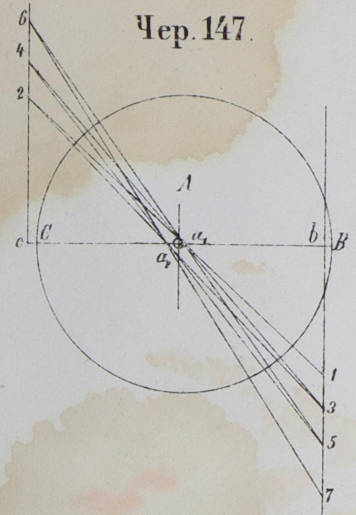
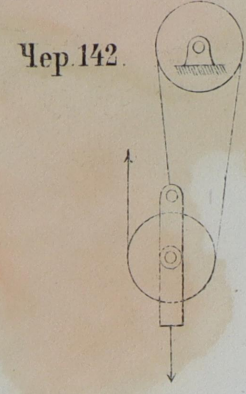
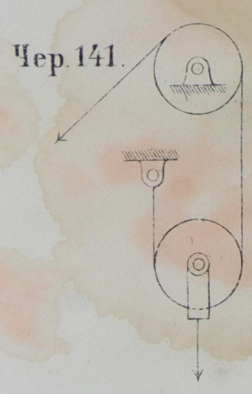

Чер. 153.

